

NEW MEXICO JUNIOR COLLEGE

BOARD MEETING

Thursday, May 20, 2004

Zia Room - Library

4:00 p.m.

AGENDA

- | | |
|--|---------------|
| A. Welcome | Larry Hanna |
| B. Adoption of Agenda | Larry Hanna |
| C. Approval of Minutes of April 19, 2004 | Larry Hanna |
| D. Correspondence | Pat Chappelle |
| E. President's Report | Dr. McCleery |
| F. Closure of Open Meeting | Larry Hanna |
| G. New Business | |
| 1. Monthly Expenditures Report | Dan Hardin |
| 2. Monthly Revenue Report | Dan Hardin |
| 3. Oil and Gas Revenue Report | Dan Hardin |
| 4. Schedule of Investments | Dan Hardin |
| 5. Fiscal Watch Reports | Dan Hardin |
| 6. Consideration of Resolution | Dr. McCleery |
| 7. Consideration of Tuition Waiver for Fire Academy Students | Rich Fleming |
| 8. Consideration of Construction Documents | Dr. McCleery |
| 9. Consideration of Grant Contract | Dr. McCleery |
| 10. Consideration of RFP #79 – Purchase & Installation of Copiers for NMJC | Frank Collins |
| 11. Consideration of RFP #84 – Audit Services for NMJC | Frank Collins |
| 12. Consideration of Bid #949RB – Road Grader for Motor Pool | Frank Collins |
| 13. Consideration of Bid #950 – Police Pursuit Vehicles for Law Academy | Frank Collins |
| 14. Consideration of Bid 951 – Materials to Build Horse Stalls for Rodeo Grounds | Frank Collins |
| 15. Consideration of President's Contract | Dr. McCleery |
| 16. Consideration of Retirement Resolutions | Dr. McCleery |
| 17. Personnel Consideration – Professor of Reading/Writing (Developmental) | Rich Fleming |
| H. Public Comments | Larry Hanna |
| I. Announcement of Next Meeting | Larry Hanna |
| J. Adjournment | Larry Hanna |

NEW MEXICO JUNIOR COLLEGE

BOARD MEETING

APRIL 19, 2004

MINUTES

The New Mexico Junior College Board met on Monday, April 19, 2004, beginning at 3:00 p.m. in the Zia Room of Pannell Library. The following members were present: Mr. Larry Hanna, Chairman; Ms. Patricia Chappelle, Secretary; Mr. Phillip Jones; Mrs. Yvonne Williams; Mr. Guy Kesner; Mr. Wade Cavitt; and Mr. John Hice, Jr.

Mr. Hanna called the meeting to order and welcomed visitors and guests present: Vange Perryman, Hobbs News Sun.

Upon a motion by Mr. Hice, seconded by Mr. Kesner, the agenda was unanimously adopted, as presented.

Upon a motion by Mr. Jones, seconded by Mr. Hice, the board unanimously approved the minutes of March 18, 2004.

Under *President's Report*, Maria Vick reported on the recent cosmetology competition and Mary Jane Ward reported on the Carl Perkins audit.

Ms. Chappelle moved the board go into closed session for the discussion of limited personnel matters under the provisions of section 10-15-1-H(2) of the New Mexico Statutes Annotated 1978. Mr. Jones seconded the motion. The roll call vote was as follows: Mr. Jones – yes; Ms. Chappelle – yes; Mr. Hice – yes; Mr. Hanna – yes; Mr. Cavitt – yes; Mrs. Williams – yes; and Mr. Kesner – yes.

Upon re-convening in open meeting, Mr. Hanna stated that the matters discussed in the closed meeting were limited only to those specified in the motion for closure.

Mr. Cavitt moved that the college accept Patricia Scott's letter of resignation effective June 30, 2004. Mrs. Williams seconded the motion which passed unanimously.

Under *New Business*, Dan Hardin presented the March financial reports and with a motion by Mr. Jones, seconded by Ms. Chappelle, the board unanimously approved the expenditures for March 2004.

Richard Fleming presented a request for a fee increase for NU 219 and NU 250 in accordance with the ATI Testing Service increasing the fees for these two courses from \$69 to \$94 effective with the Fall 2004 semester. Upon a motion by Mr. Kesner, seconded by Mrs. Williams, the board unanimously approved the request. Dr. Fleming

requested a fee increase for telecollege courses from \$22 to \$30. A portion of this fee will be used to pay the license fee for the Introduction to Philosophy course. Upon a motion by Mr. Chappelle, seconded by Mr. Cavitt, the board unanimously approved the request. Dr. Fleming recommended a \$31 course fee increase (from \$215 to \$246 per student) for the Driver Education program effective July 12, 2004. Upon a motion by Ms. Chappelle, seconded by Mr. Cavitt, the board unanimously accepted the recommendation. Dr. McCleery recommended a \$1.00 per credit hour increase in the Information Technology fee. Upon a motion by Mr. Kesner, seconded by Mr. Hice, the board unanimously accepted the recommendation.

Dr. McCleery recommended that the board approve the 2004/2005 budget as presented at the work session. The contact hour plan will be studied and phased in over a five year period. \$3.6 million will be moved to the capital fund. After some discussion and upon a motion by Mr. Jones, seconded by Ms. Chappelle, the board unanimously approved the budget. Dr. McCleery recommended a compensation dollar amount of \$243,000 or approximately a 3% compensation increase. There are two new positions – Recruiter and Director of the Western Heritage Center. Mr. Hice made a motion to approve the recommendation and Ms. Chappelle seconded the motion. The vote was as follows: Mr. Jones – yes; Ms. Chappelle – yes; Mr. Hice – yes; Mr. Hanna – yes; Mr. Cavitt – yes; Mrs. Williams – yes; and Mr. Kesner – No.

Lisa Brown presented the recommended changes for the 2004-2005 employee handbook. After some discussion and upon a motion by Mr. Hice, seconded by Ms. Chappelle, the board unanimously approved the handbook with changes.

Frank Collins presented Request for Proposals #81 – Career Mobility Nursing Program. The administration recommended acceptance of the services of Davis Nursing Education Services for \$38,000. Mr. Hice made a motion to approve the recommendation and Ms. Chappelle seconded the motion. The roll call vote was as follows: Mr. Jones – yes; Ms. Chappelle – yes; Mr. Hice – yes; Mr. Hanna – yes; Mr. Cavitt – yes; Mrs. Williams – yes; and Mr. Kesner – No.

Mr. Collins presented Request for Proposals #82 – New Mexico Junior College Community Survey. The administration recommended acceptance of the services of Robinson & Muenster Associates, Inc. for \$13,956. Upon a motion by Mr. Kesner, seconded by Mrs. Williams, the board unanimously accepted the recommendation.

Dr. McCleery presented a retirement resolution for Sam Oswald. Mr. Oswald has served the college for 14 years and has elected to retire effective April 16, 2004. Upon a motion by Mr. Jones, seconded by Mr. Cavitt, the board unanimously adopted the resolution with regrets.

Mr. Hanna called for comments from the community. There being none, the next regular board meeting was scheduled for May 20, 2004, beginning at 4:00 p.m. in the Zia Room of Pannell Library.

Upon a motion by Mr. Cavitt, seconded by Mr. Kesner, the board meeting adjourned at 4:40 p.m.

CHAIRMAN

ATTEST: _____
SECRETARY

NEW MEXICO JUNIOR COLLEGE

Vice President for Finance

To: **New Mexico Junior College Board Members**

From: Dan Hardin

Date: May 13, 2004

RE: Expenditure and Revenue Reports for April 2004

April is month ten or 84% of the budget for the 2003/2004 fiscal year. The expenditure report represents funds expended and encumbered. The total year-to-date funds expended and/or encumbered through the month of April is \$23,874,148.00 of which \$1,550,028.00 are encumbered funds.

The total current unrestricted fund expenditures for Current Unrestricted Funds through April are \$14,156,788.00, which is 86% of the projected budget. Instruction expenditures normally run \$460,000.00 to 470,000.00 per month. In April we began paying the summer payrolls for the faculty, increasing the expenditures to \$1,053,156.00. As has been previously indicated Internal Service Departments will have a budget transfer in June to cover maintenance costs on the Docutech. Student Aid is over budget due to Tuition Waivers.

In the Restricted Funds Grants continue to expend funds, most grants do not end their year until September or October.

In the Plant Funds expenditures are for the completion of the Infrastructure project, the JASI Software, and the construction drawings for Western Heritage and Ben Alexander capital projects.

Total expenditures for the month were \$2,151,463.00.

Revenue generated in April was \$1,479,586.00. This mostly consists of the monthly allocation from the state, the oil and gas and oil and gas equipment tax income, grant and direct loan drawdowns.

The actual oil and gas tax revenue for March was \$408,619.00, the accrual for April was the same \$239,507.00. Total oil & gas and oil & gas equipment tax revenue year-to-date is \$4,011,380.00, which is \$1,169,897.00 over the projected budget through ten months of the budget.

Restricted Funds had \$144,327.00 in revenue for April, the result of drawdowns from grants and direct loans for students.

Total revenue for April 2004 is \$1,479,586.00, with year-to-date revenue of \$23,512,589.00 or 77% of projected budget.

The investment report shows an ending balance in the Local Governmental Investment Pool of \$10,125,000.00. Of the \$10,125,000.00 in LGIP, \$5,472,592.19 or 54% is designated as capital projects. The balances for capital projects include what has been expended, but does not include what has been encumbered. In May the business office will make the transfers from reserves for capital projects that were approved in the last board meeting

The CHE (Commission on Higher Education) budget was delivered on time to the commission staff. I would like to thank the Board for your diligent work on the budget and for allowing the time to complete the CHE budget.

This concludes the Financial Report for April 2004.

NEW MEXICO JUNIOR COLLEGE
Expenditure Report
April 2004

84% of Year Completed

Fund	2002-03			2003-04			
	Final Budget	Year-to-Date Expended or Encumbered	Percentage of Budget Expended	Original Budget	Current Expended or Encumbered	Year-to-date Expended or Encumbered	Percentage of Budget Expended
CURRENT UNRESTRICTED FUND							
Instruction and General:							
Instruction	4,812,332	4,921,418	102%	6,469,404	1,053,156	4,946,626	76%
Academic Support	911,970	1,091,144	120%	1,308,171	82,187	1,062,111	81%
Student Services	1,069,344	1,262,697	118%	1,480,107	127,366	1,263,126	85%
Institutional Support	3,726,901	2,100,807	56%	2,169,551	176,152	1,961,435	90%
Operation & Maintenance of Plant	1,748,024	1,572,334	90%	1,932,913	175,267	1,822,345	94%
Subtotal - Instruction & General	12,268,571	10,948,400	89%	13,360,146	1,614,128	11,055,643	83%
Student Activities	290,976	284,795	98%	315,714	64,431	303,891	96%
Research	0	0	0%	0	0	0	0%
Public Service	0	0	0%	0	0	0	0%
Internal Service Departments	683,216	199,365	29%	420,854	4,674	578,206	137%
Student Aid	281,479	214,784	76%	179,889	2,611	253,094	141%
Auxiliary Enterprises	1,197,047	1,490,355	125%	1,457,789	78,427	1,427,643	98%
Athletics	568,428	590,687	104%	698,906	52,510	538,311	77%
Total Current Unrestricted Fund	15,289,717	13,728,386	90%	16,433,298	1,816,781	14,156,788	86%
CURRENT RESTRICTED FUND							
Grants	2,783,775	1,861,043	67%	2,013,499	214,813	1,458,855	72%
Student Aid	3,964,907	4,554,971	115%	4,180,325	21,757	4,595,502	110%
Total Current Restricted Fund	6,748,682	6,416,014	95%	6,193,824	236,570	6,054,357	98%
PLANT FUNDS							
Capital Outlay / Bldg. Renewal & Repl.							
Projects from Institutional Funds	5,944,312	1,720,601	29%	6,363,403	65,083	799,974	13%
Projects from State GOB Funds	1,212,900	1,168,366	96%	5,226,697	27,108	2,535,899	49%
Projects from State STB Funds	0	0	0%	1,980,000	0	103,481	0%
Projects from State E R & R	0	0	0%	270,971	0	0	0%
Projects from State B R & R	327,399	327,133	100%	390,082	5,921	219,810	56%
Projects from Auxiliary BR&R	39,009	32,756	84%	19,539	0	3,839	20%
Subtotal - Capital and BR&R	7,523,620	3,248,856	43%	14,250,692	98,112	3,663,003	26%
Debt Service							
Revenue Bonds	0	0	0%	0	0	0	0%
Total Plant Funds	7,523,620	3,248,856	43%	14,250,692	98,112	3,663,003	26%
GRAND TOTAL EXPENDITURES	29,562,019	23,393,256	79%	36,877,814	2,151,463	23,874,148	65%

NEW MEXICO JUNIOR COLLEGE
Revenue Report
April 2004

84% of Year Completed

Fund	2002-03			2003-04			
	Final Budget	Year-to-date Revenue	Percentage of Budget Received	Original Budget	Current Month Revenue	Year-to-date Revenue	Percentage of Budget Received
CURRENT UNRESTRICTED FUND							
Instruction and General:							
Tuition and Fees	1,356,355	1,257,417	93%	1,653,150	17,467	1,545,795	94%
State Appropriations	7,376,100	6,146,830	83%	7,684,800	619,358	6,558,871	85%
Advalorem Taxes - Oil and Gas	2,949,084	3,845,270	130%	3,409,779	409,036	4,011,380	118%
Advalorem Taxes - Property	1,800,000	1,650,137	92%	2,000,000	81,851	1,694,103	85%
Interest Income	50,000	50,553	101%	50,000	5,399	29,555	59%
Other Revenues	307,700	380,246	124%	316,500	38,793	264,572	84%
Subtotal - Instruction & General	13,839,239	13,330,453	96%	15,114,229	1,171,904	14,104,276	93%
Student Activities	43,400	47,292	109%	47,500	44	47,206	99%
Public Service	0	0	0%	0	0	0	0%
Internal Service Departments	10,000	11,059	111%	13,000	1,419	9,995	77%
Auxiliary Enterprises	1,663,000	1,688,523	102%	1,728,300	24,392	1,690,854	98%
Athletics	35,400	29,069	82%	35,400	2,875	29,171	82%
Total Current Unrestricted	15,591,039	15,106,396	97%	16,938,429	1,200,634	15,881,502	94%
CURRENT RESTRICTED FUND							
Grants	2,347,254	1,332,409	57%	2,013,499	109,057	1,108,931	55%
Student Aid	3,716,407	4,150,821	112%	4,180,325	35,270	4,578,241	110%
Total Current Restricted	6,063,661	5,483,230	90%	6,193,824	144,327	5,687,172	92%
PLANT FUNDS							
Capital Outlay / Bldg. Renewal & Repl.							
Projects from State GOB Funds	1,212,900	791,136	65%	4,593,986	43,746	1,676,681	36%
Projects from State STB Funds	0	0	0%	2,000,000	79,943	165,653	8%
Projects from Other State Funds	0	0	0%	680,399	0	0	0%
Interest Income	105,700	84,551	80%	100,000	10,936	101,581	102%
Total Plant Funds	1,318,600	875,687	66%	7,374,385	134,625	1,943,915	26%
GRAND TOTAL REVENUES	22,973,300	21,465,313	93%	30,506,638	1,479,586	23,512,589	77%

NEW MEXICO JUNIOR COLLEGE

Oil and Gas Revenue Report

April 2004

84% of Year Completed

		OIL		GAS		COMBINED		
Sales	Month of Distribution	Price per BBL	Lea County BBLs sold	Price per MCF	Lea County MCF sold	Monthly Revenue	2002-03 Original Budget	Variance Over (Under) Budget
Actual	July	\$26.85	2,991,006	\$4.48	16,317,305	343,217	239,507	103,710
Actual	August	\$25.32	3,451,574	\$5.26	15,862,113	337,799	239,507	98,292
Actual	September	\$25.39	3,597,704	\$4.80	17,349,678	321,605	239,507	82,098
Actual	October	\$30.08	3,068,996	\$4.56	17,740,094	427,926	239,507	188,419
Actual	November	\$26.37	2,877,972	\$4.52	16,425,079	297,713	239,507	58,206
Actual	December	\$28.16	3,127,825	\$4.39	17,293,973	341,121	239,507	101,614
Actual	January	\$29.63	2,987,545	\$4.25	16,321,118	309,412	239,507	69,905
Actual	February	\$30.37	3,173,669	\$4.74	17,433,910	356,805	239,507	117,298
Actual	March	\$32.33	3,170,048	\$5.64	17,607,065	408,619	239,507	169,112
Accrual	April					239,507	239,507	0
	May						239,507	(239,507)
	June						239,507	(239,507)
Y.T.D. Production Tax Revenue						3,383,724	2,874,084	509,640
Y.T.D. Equipment Tax Revenue						627,656	535,695	91,961
Total Year-to-Date Oil & Gas and Equipment Tax Revenue						4,011,380	3,409,779	601,601

Source: New Mexico Taxation and Revenue Department

Per Johnson, Miller & Co., C.P.A.'s, an accrual is made for oil and gas revenue for the reporting month. April is the monthly budget amount.

NEW MEXICO JUNIOR COLLEGE Schedule of Investments April 2004

84% of Year Completed

Financial Institution	Amount Invested	Date Invested	Maturity Date	Period of Investment (Days)	Account Number	Interest Rate	Interest Earned
State of New Mexico Local Government Investment Pool	10,125,000	N/A	N/A	N/A	7102-1348	1.87%	16,341
Total investments	<u>10,125,000</u>						<u>16,341</u>

Summary of Current Month's Activity	
Beginning amount	10,125,000
Plus: deposits	0
Less: withdrawals	0
Capital Projects	5,472,593
Reserves Invested	4,652,407
Total LGIP Investment	10,125,000

Capital Projects	4/30/2004
Technology Upgrade	115,725.20
Workforce Training Center	1,191,750.14
High Tech Start Up	201,296.00
Docutech	175,000.00
Vehicles	35,655.62
CISCO Networking Equipment	4,188.53
Western Heritage Center	500,000.00
Drawings and Master Plan	44,963.70
Baseball Field	95,949.68
Rodeo Arena	11,533.96
Dormitory Landscape	45,900.93
Lea County Beautification	0.00
Circle Drive	93,632.64
Dorm Construction	0.00
Roadway Parking Lot Seal Coat	50,000.00
Dorm Recreation Area	117,238.41
BR&R Carryover	19,539.49
Water Rights	9,465.59
Firing Range Upgrade	6,564.13
Millen Fence/Landscape	100,000.00
Ben Alexander Student Center	2,365,438.94
JASI	288,750.23
Total	5,472,593.19

NOTE: Capital projects total does not include encumbered funds

NEW MEXICO JUNIOR COLLEGE

Vice President for Finance

5317 Lovington Highway
Hobbs, NM 88240
Phone: (505)392-5210
Fax: (505)392-2526

To: NMJC Board members
From: Dan Hardin
RE: Fiscal Watch Reports
Date: May 20, 2004

Board members, the Commission on Higher Education changed the requirement for the fiscal watch reports from semi annual to quarterly reports. The college is required to provide a Balance Sheet, a comparison of Operating and Plant Funds, a summary of Operating and Plant Funds, and a cash flow statement. These statements are as of March 2004 and follow the Board reports from March.

Thanks,



Dan Hardin

NEW MEXICO JUNIOR COLLEGE

Balance Sheet (Unaudited and Unadjusted) As of 3/31/04

Assets

Current Assets:

Cash and Cash Equivalents	893,510
Investments	10,125,000
Accounts Receivable, net	431,787
Inventories	303,780
Prepaid Expenses	196,395

Total Current Assets 11,950,472

Non-Current Assets

Property, Plant and Equipment, net	10,942,783
Construction in Progress	1,452,190

Total Non-Current Assets 12,394,973

Total Assets 24,345,445

Liabilities

Current Liabilities

Accounts Payable	13,849
Accrued Wages Payable	130,682
Deferred Revenue	23,848
Accrued Liabilities	381,840
Scholarships payable	31,194
Other Payables	

Total Current Liabilities 581,413

Total Liabilities 581,413

Net Assets

Invested in Capital Assets, net of Related Debt	9,719,374
Unrestricted	14,044,658

Total Net Assets 23,764,032

NEW MEXICO JUNIOR COLLEGE
Comparison of Operating and Plant Funds
(Unadjusted and Unaudited)
Fiscal Year 2002-2003 and 2003-2004

Operating Funds	Actuals as of 3/31/2003	Actuals as of 3/31/2004	Percentage Increase (Decrease)
REVENUES			
Tuition & Fees	1,235,158	1,528,328	23.7%
State Appropriations	5,532,147	5,939,513	7.4%
Local Appropriations	5,014,541	5,214,596	4.0%
Sales & Service	1,716,943	1,722,200	0.3%
Other	446,798	276,231	-38.2%
Total Revenues	13,945,587	14,680,868	5.3%

EXPENDITURES

Instruction & General	9,548,738	9,441,515	-1.1%
Student Social & Cultural	226,235	239,460	5.8%
Internal Services	252,660	573,532	127.0%
Student Aid	208,058	250,483	20.4%
Auxiliary Enterprises	1,382,747	1,349,216	-2.4%
Intercollegiate Athletics	533,464	485,801	-8.9%
Total Expenditures	12,151,902	12,340,007	1.5%
Increase (decrease) in Fund Balances	1,793,685	2,340,861	

Plant Funds

REVENUES			
Interest Income	76,141	90,645	19.0%
State Funds	774,170	1,718,645	
Other			
Total Revenue	850,311	1,809,290	112.8%

EXPENDITURES

Capital Projects	2,917,632	3,347,163	14.7%
Building R&R	259,446	213,889	-17.6%
Equipment R&R			
Auxiliary R&R	34,556	3,839	-88.9%
Total Expenditures	3,211,634	3,564,891	11.0%

Increase (Decrease) in Fund Balances -2,361,323 -1,755,601

NEW MEXICO JUNIOR COLLEGE
Summary of Operating and Plant Funds
(Unadjusted and Unaudited)
Fiscal Year 2003 - 2004

March 31 2004

Operating Funds	FY 2003-2004 Original Budget	FY 2003-2004 Actual as of 3-31-04	Percentage of Budget Earned or Expended
REVENUES			
Tuition & Fees	1,653,150	1,528,328	92.45%
State Appropriations	7,684,800	5,939,513	77.29%
Local Appropriations	5,409,779	5,214,596	96.39%
Sales & Service	1,788,800	1,722,200	96.28%
Other	401,900	276,231	68.73%
Total Revenues	16,938,429	14,680,868	86.67%

EXPENDITURES

Instruction & General	13,359,795	9,441,515	70.67%
Student Social & Cultural	315,714	239,460	75.85%
Internal Services	420,854	573,532	136.28%
Student Aid	179,889	250,483	139.24%
Auxiliary Enterprises	1,457,789	1,349,216	92.55%
Intercollegiate Athletics	698,906	485,801	69.51%
Total Expenditures	16,432,947	12,340,007	75.09%
Increase (decrease) in Fund Balances	505,482	2,340,861	

Plant Funds

REVENUES			
Interest Income	100,000	90,645	90.65%
State Funds	7,274,385	1,718,645	23.63%
Other			
Total Revenue	7,374,385	1,809,290	24.53%

EXPENDITURES

Capital Projects	13,568,202	3,347,163	24.67%
Building R&R	390,082	213,889	54.83%
Equipment R&R	273,220	-	0.00%
Auxiliary R&R	19,539	3,839	19.65%
Total Expenditures	14,251,043	3,564,891	25.01%

Increase (Decrease) in Fund Balances	-6,876,658	-1,755,601
--------------------------------------	------------	------------

**NEW MEXICO JUNIOR COLLEGE
STATEMENT OF CASH FLOWS**

March 31, 2004

Cash flow from operating activities:

Tuition and fees	1,528,328.00
Federal and state grants and contracts	5,542,845.00
Auxiliary enterprise charges	1,666,462.00
Other operating revenue	180,783.75
Payments to employees, benefits, and suppliers	-13,201,260.92
Disbursement of net aid to students	-4,573,745.00

Net cash used by operating activities -8,856,587.17

Cash flows from noncapital financing activities

State appropriations	5,939,513.00
Local appropriations	5,214,596.00
Other nonoperating receipts	82,034.00
Gifts	0.00

Net cash provided by noncapital financing activities 11,236,143.00

Cash flows from capital financing activities

Interest from capital asset related debt	114,801.00
Capital appropriations	1,718,645.00
Purchases of capital assets	-2,337,323.27
Sale of capital assets	44,995.25

Net cash used for capital financing activities -458,882.02

Cash flows from investing activities

Purchase of investments (LGIP)	-1,900,000.00
--------------------------------	---------------

Net cash used for investing activities -1,900,000.00

Net decrease in cash and cash equivalents 20,673.81

Cash and cash equivalents - beginning of year 183,983.00

Cash and cash equivalents - March 31, 2004 204,656.81



Vice President for Instruction

NEW MEXICO JUNIOR COLLEGE

MEMORANDUM

DATE: April 28, 2004
TO: New Mexico Junior College Board Members
FROM: Richard Fleming, Vice President for Instruction *RBF*
SUBJECT: Tuition Waiver for Fire Academy Students

In 1998, the New Mexico Junior College Board authorized tuition waivers for Hobbs Police Department officers attending the law enforcement academy. This was done primarily because the police department was providing academy instructors, equipment, and training facilities (indoor shooting range, fire arms training equipments, etc.).

The College has worked with the Hobbs Fire Department in the past to conduct two other academies. We believe our cooperation with them benefits the community and the college. One of the academies was 20 weeks and another was 13 weeks. They are proposing another 13 week academy totaling 32 credit hours in 11 courses. However, even though the HFD encourages students to enroll for credit, students are not required to do so even though they can still attend the academy.

I am proposing that tuition waivers be extended to the Hobbs Fire Department for academy courses when we co-sponsor the academy. The HFD provides all of the required equipment (bunker gear, vehicles, breathing apparatus, and miscellaneous equipment/tools) necessary for conducting the fire academy. NMJC provides the facilities for the class and reimburses the HFD \$1,000 per course so we can collect state funding.

Thank you for you consideration.



NEW MEXICO JUNIOR COLLEGE

Office of the President

Memo

DATE: May 13, 2004
TO: New Mexico Junior College Board Members
FROM: Steve McCleery *Sm*
SUBJECT: Construction Documents for the Ben Alexander Student Center and the Western Heritage Center

Attached you will find the construction documents for the Ben Alexander Student Center and the Western Heritage Museum. Based on the update from the architects, I am seeking approval of construction and bid documents for the Ben Alexander Student Center and the Western Heritage Center. The next action for the New Mexico Junior College Board will be to approve and award the construction contract.

Thank you for your consideration.

May 10, 2004

Dr. Steve McCleery
President
New Mexico Junior College
5317 Lovington Highway
Hobbs, NM 88240

RE: Western Heritage Center and Ben Alexander Student Learning Center:
Bidding Method

Dear Dr. McCleery:

We understand that there have been questions raised about the best way to bid this project. Our documents currently have both projects being constructed under one contract by one general contractor. The primary reasons for using this method are to attract contractors with more experience in complex projects for a quality building and for "economy of scale" to get more building for our construction dollar.

As contractors become more experienced and complete projects successfully they are able to bond projects with higher construction costs. Therefore the assumption is that if they can bond at a higher construction cost they have produced good projects. We want a contractor with experience and the bonding capacity for larger projects. We've been told that if these projects are bid separately then some of the larger contractors will not be interested in bidding. With more contractors bidding the project we will receive a more competitive bid (which translates to a lower bid).

The "economy of scale" that we mentioned means that there will be a savings in contractor overhead and general conditions because there will only be one contractor as opposed to two contractors each invoicing for this expense. Some of the items that General Conditions include are job site trailers, trucks, equipment, mobilization and management. If there are two contractors NMJC will be paying both contractors for these items. Also, there will a savings with subcontractors who also have to provide these items.

There will also be a savings in purchasing in quantity. We have provided similar building materials for both buildings to provide the economy of scale that we discussed earlier in this letter. A single contractor may get a reduction in costs by buying products for two facilities instead of one and that savings will be realized by NMJC.

Another issue is that we are currently in the process of qualifying contractors for a \$7,000,000 project that includes both buildings. In so doing we have already eliminated contractors who can only bond a \$3,000,000 or \$4,000,000 project. It would seem that we have already committed to combining both buildings into a single contract for a contractor who submits acceptable qualifications. A change in the award of the contract would require that we publish a legal advertisement canceling the pre-qualification for a \$7,000,000 project and a new one for a \$3,000,000 project. This would postpone bidding the project.

Dr. Steve McCleery
New Mexico Junior College
May 10, 2004
Page 2

When bidding a project our documents must be very clear as to how the project is going to be awarded. We are not permitted to change the method of award after the bids are received. We therefore cannot tell the contractors that we are receiving a single bid for both projects and then award separate contracts after that. We are sure to receive protests and that will delay the start of construction.

The bid documents are 99% complete. If we are directed to change the bidding procedure to separate bids this will require changes to our documents and will require more time to prepare the bid documents. This too will delay the bidding and construction activities.

We've talked to both of the contractors in Hobbs and they are planning on bidding on this project. Our recommendation at this time is that we bid both projects as one contract and that we select alternates after the bids are submitted.

Please let us know if you have questions regarding these items that have been discussed in this letter. We will be happy to explain any of our comments in greater detail. We enjoy and appreciate working with you and your staff, thank you.

Very truly yours,

Dekker/Perich/Sabatini Ltd.

Annelle M. Darby, AIA
Associate

■ ■ ■
6801 Jefferson NE
Suite 100
Albuquerque NM
87109
505 761.9700
fax 761.4222
dps@dpsabq.com

**2004 Building Program
Western Heritage Center and Ben Alexander Student Learning Center
New Mexico Junior College, Hobbs, New Mexico**

SECTION 00001 - PROJECT DIRECTORY

Owner: _____ New Mexico Junior College
5317 Lovington Highway
Hobbs, New Mexico 88240

Architectural/Structural: _____ Dekker/Perich/Sabatini, Ltd.
6801 Jefferson NE, Suite 100
Albuquerque, New Mexico 87109
Phone: (505) 761-9700
Fax: (505) 761-4222

Mechanical/Electrical: _____ Bridgers and Paxton Consulting Engineers
4600-C Montgomery NE
Albuquerque, New Mexico 87109
Phone: (505) 883-4111
Fax: (505) 888-1436

Civil: _____ Pettigrew & Associates
1110 No. Grimes
Hobbs, New Mexico 88240
Phone: (505) 393-9827
Fax: (505) 393-1543

Landscape: _____ Dekker/Perich/Sabatini, Ltd.
6801 Jefferson NE, Suite 100
Albuquerque, New Mexico 87109
Phone: (505) 761-9700
Fax: (505) 761-4222

END OF SECTION

**2004 Building Program
Western Heritage Center and Ben Alexander Student Learning Center
New Mexico Junior College, Hobbs, New Mexico**

**SECTION 00100 - ADVERTISEMENT FOR BIDS
FOR
PRE-QUALIFIED CONTRACTORS**

Sealed bids for the **2004 Building Program - Western Heritage Center and Ben Alexander Student Learning Center** will be received from those contractors who have been pre-qualified to bid on this project at New Mexico Junior College (as Owner), John Shepherd Administrative Center, Purchasing Office, until June 22, 2004 at 2:00 p.m. (local time). The campus address is 5317 Lovington Highway, Hobbs, NM 88240. Bids received after this time will not be accepted. Bids will be opened and publicly read aloud at the time the bids are due.

The contractors who are pre-qualified are:

The Bidding and Contract Documents will be available May 25, 2004 and may be examined at:

F.W. Dodge Co.
1615 University Blvd., NE
Albuquerque, NM 87102
(505) 243-2817

Construction Reporter
1607 Second, NW
Albuquerque, NM 87102
(505) 243-9793

Builder's News
3435 Princeton Dr., NE
Albuquerque, NM 87107
(505) 884-1752

Reed Construction Data/CMD Plan Room
3351 Candelaria NE, Suite D
Albuquerque, NM 87107
(505) 881-8590

Copies of the above documents may be obtained at the offices of:

Albuquerque Reprographics
4716 McLeod NE
Albuquerque, NM 87109
(505) 884-0862

In accordance with the Instructions to Bidders, and upon depositing the sum of \$150.00 for each set of documents, prospective bidders may obtain a copy of the bidding and construction documents. Any prospective bidder upon returning the documents in good condition within (10) days, following the bid opening, will be refunded that deposit. General Contractors may receive up to 3 sets of the bidding and construction documents. All other prospective bidders may receive only 1 set.

The bidder's attention is directed to the requirements of the Contract Documents for adherence to applicable federal, state, and local statutes, regulations and ordinances, payment of minimum wages, and payment of taxes.

Bid security in the amount of five percent (5%) of the amount of the Bid must accompany each Bid in accordance with the Instructions to Bidders. The successful bidder shall provide a Performance Bond and a Payment Bond in the amount of one hundred percent (100%) of the contract. Minimum wage rates and benefits shall be paid as determined by the State of New Mexico Department of Labor, and the U.S. Department of Labor.

The Owner reserves the right to waive irregularities and to reject any Bids. Bids shall be good for 30 days following the opening of the bids and may be withdrawn pending Owner action.

A Pre-bid Conference will be held at New Mexico Junior College located at the above address at 9:00 am local time, on June 1, 2004 at the Ben Alexander Student Center.

Refer to the Instructions To Bidders, contained in the bidding and construction documents, for instructions related to clarifications and addenda regarding the bidding and construction documents.

Pre-Bid Conference Date: June 1, 2004
Bid Opening Date: June 22, 2004
Publication Dates (Albuquerque Journal, Albuquerque Tribune, Hobbs News-Sun, Lubbock Avalanche-Journal, Odessa American and Midland Reporter-Telegram.)
First Publication: May 26, 2004
Second Publication: May 30, 2004
Third Publication: June 8, 2004

END OF SECTION

**2004 Building Program
Western Heritage Center and Ben Alexander Student Learning Center
New Mexico Junior College, Hobbs, New Mexico**

SECTION 00200 - INSTRUCTIONS TO BIDDERS

EXAMINATION:

Bidders shall familiarize themselves with federal, state, and local laws, ordinances, rules and regulations affecting performance of the Work and employment of labor; and carefully examine the proposed Contract Documents and the construction site to obtain first-hand knowledge of all proposed Work and existing improvements and conditions at the site. Contractors will not be entitled to any additional compensation or any extension of the Contract Time for conditions that can be determined by examining the site and the Bidding and Contract Documents. Submission of a Bid constitutes a representation by the bidder that the bidder has made all appropriate examinations, investigations and tests and has made provision as to the cost thereof in his bid. It is the responsibility of each bidder, sub-contractor, and material supplier to examine the documents for the work of all trades that may have an effect on the work that the bidder, sub-contractor, or supplier intends to perform.

INTERPRETATIONS, CLARIFICATIONS, AND ADDENDA:

Submit all questions regarding the proposed Contract Documents to the Project Architect (refer to the Project Directory, Section 00001) in writing at least seven (7) calendar days prior to Bid Opening. Include any discrepancies, omissions, or ambiguities noted by any Bidder. If appropriate, the Architect will issue a written Addendum that shall thereafter become part of the Bid Documents and Contract Documents. Architect shall give no oral interpretations and, if given, such shall not be binding upon Owner unless included in a written Addendum issued prior to Bid Opening. No Addenda will be issued later than three (3) days before Bid Opening, except an Addendum, if necessary, postponing the date for receipt of Bids or withdrawing the request for Bids. All bids shall be responsive to and include the provisions of all Addenda issued prior to Bid Opening. It is the intent of the Owner to select alternates as a means to achieve the amount of funding available to construct the project. The alternates will be selected in random order by the Owner to fit the construction budget.

SUBSTITUTIONS:

The Owner reserves the right to be the sole judge as to whether or not a different process, type of equipment, or kind of material offered is in fact the equal to that specified. **Requests to use unspecified products will not be reviewed during the bidding period.** Prior approval to use unspecified products will not be given. Substitution Requests to use unspecified products will be considered after Contract award under procedures specified in Section 01600 - Product Requirements.

BID FORMS:

Bids must be submitted on the prescribed Bid Form without alteration. (See Section 00410). Fill in all blank spaces neatly, in ink, or typewritten. In case of a conflict between the words and figures, the words will govern. Bids shall be signed with the name and title/position of the signatory typed below the signature. If the Bid is submitted by a sole proprietorship, it shall be signed by the individual Owner. If the Bid is submitted by a joint venture or general or limited partnership, the name and address of each joint venture member or general partner must be listed by an authorized general partner or joint venture member. If the Bid is submitted by a corporation, the corporate name and business address must be given and the Bid signed by either the President or an authorized Vice President of the Corporation. Include the New Mexico Contractor's License Number and the resident Contractor's Certificate Number. Any written changes must be initialed by the person signing the Bid. Bids in which acceptance is in some manner restricted or conditioned by the bidder will be reviewed by the Owner. If the limitations imposed are not in the best interest of the Owner, or are prejudicial to other bidders, the bid will be rejected.

BID SECURITY:

Each Bid must be accompanied by a Bid Bond (properly executed on AIA Document A310, or otherwise supplied in a form satisfactory to the Owner, issued by a surety that is both an approved surety on the current Federal Register for approved securities issued by the U.S. Department of Treasury. The surety shall also be currently licensed and otherwise authorized to issue surety bonds in New Mexico, such bond to be in an amount of not less than 5% of the Bid, for the benefit of the Owner. The bond shall be given as a guarantee that the bidder will enter into an Agreement with the Owner as provided for in the Bidding and Contract Documents and furnish the required

payment/performance bonds and insurance certificates and endorsements if awarded the contract for the Project. If the Bidder's Bid is accepted by the Owner within 30 days after Bid Opening, then should the bidder fail to execute the Agreement called for in the proposed Contract Documents and deliver to Owner the required bonds/insurance certificates/insurance endorsements, and other documents called for in the proposed Contract Documents within 10 days after Notice of Award (or satisfactory evidence that such documents will be furnished); then Owner may collect on the bond and recover appropriate damages and terminate any and all rights or interest of the Bidder with respect to the Project or the Work.

Unless all bids are rejected by Owner, the Bid Security of the lowest responsive bidder at Bid Opening shall be retained until execution of the Agreement; unless prior to the Notice of Award, but after 30 days following the Bid Opening, such bidder has withdrawn his Bid in writing and delivered to the Owner. The Bid Security of unsuccessful bidders shall be returned to them promptly.

SUBCONTRACTORS (NEW MEXICO SUBCONTRACTORS FAIR PRACTICES ACT):

Names and addresses of each subcontractor, under contract to the Bidder, who will perform labor or render services to the Bidder in an amount in excess of the listing threshold of either \$5,000.00 or 1/2 of 1% of 90% of the estimated project cost, whichever is greater shall be provided on List of Subcontractors Form. See Sections 00430 and 00431 and the Bid Form, pursuant to the New Mexico Subcontractors Fair Practices Act. There shall be only one subcontractor listed for each classification. If a Bidder fails to specify a subcontractor in excess of the listing threshold, the Bidder represents that he is fully qualified to perform that portion himself. If after the award of the contract, the Contractor subcontracts any portion of the work, except as provided in the Subcontractors Fair Practices Act, the Contractor shall be guilty of violation of the Subcontractors Fair Practices Act and subject to the penalties provided therein. The Owner reserves the right to disqualify subcontractors and suppliers in accord with the Conditions of the Contract. Contractor may not change any of the subcontractors/suppliers so listed without Owner's consent. Owner's right to object following Notice of Award and execution of the Agreement to any subcontractor/Supplier listed shall be as provided in the Contract Documents (particularly Article 5 of the General Conditions as amended by the Supplementary Conditions). Should Owner object to any listed supplier or subcontractor prior to the Notice of Award, and Contractor fails to promptly secure an alternative subcontractor/supplier acceptable to Owner, then such shall be a basis for Owner rejecting a Bid as unresponsive.

SUBMITTAL OF BID:

Deliver Bid Form, Bid Security, and Listing of Subcontractors for Compliance with the Subcontractor's Fair Practices Act in an opaque sealed envelope to the location identified in the Invitation to Bid. Identify the envelope with the project name, bid number, name of the Bidder, and the time and date of the Bid Opening. Each bid must be submitted on the prescribed forms. All blank spaces for bid prices must be filled in with ink or typewritten. Corrections shall be initialed in ink by person signing the bid.

MODIFICATION AND WITHDRAWAL:

A bid containing a mistake discovered before bid opening may be modified or withdrawn by a bidder prior to the time set for bid opening by delivering written or telegraphic notice to the location designated in the invitation for bids as the place where bids are to be received. After bid opening, no modifications in bid prices or other provisions of bid shall be permitted.

BID OPENING:

Bids will be opened and publicly read aloud. Bids received after the time and date established by the Bid Opening shall be returned unopened. The reading of Bids is for information only and is not to be construed as acceptance or rejection by the Owner.

PROTEST:

Any bidder who is aggrieved in connection with a procurement action may protest to the Owner. The protest shall be submitted in writing not more than 15 calendar days after the fact or occurrences giving rise thereto.

DISQUALIFICATION:

The Owner reserves the right to disqualify or reject any or all Bids, before or after opening. The Procurement Code, Sections 13-1-28 through 13-1-199 NMSA, imposes civil and criminal penalties for its violation. In addition, the New Mexico criminal statutes impose felony penalties for illegal bribes, gratuities and kickbacks.

AWARD:

Owner reserves the right to select the schedule(s) and appropriate combination of Base Bids plus Alternates under which the Bids are compared and any contract awarded; to reject any and all Bids; and to waive any irregularities in any Bid. The listed order of alternates is **not** prioritized. The Owner may select any alternates from any position to yield the lowest responsive bid at the discretion of the Owner.

EXECUTION OF CONTRACT/COMPLIANCE WITH BID INSTRUCTIONS:

By submitting a Bid, each bidder acknowledges his understanding of these Instructions to Bidders and his willingness to comply with the requirements of the Bid Documents. If the Bidder's Bid is accepted by Owner, such Bidder shall execute the Agreement and provide the instruments/documents called for in the Bid Documents (or in the proposed Contract Documents) within ten (10) working days after the Notice of Award, subject to forfeiture of its Bid security if such is not timely done. Bidder further acknowledges his understanding of the payment/performance bond requirements and insurance requirements called for in the proposed Contract Documents.

RESIDENT PREFERENCE:

It will be the sole responsibility of the Bidders requesting consideration for Resident Preference at Bid Opening to submit to the State Purchasing Agent the questionnaire for Resident Contractor's Certification and to receive approval and a certification number from the State Purchasing Agent, which must be included on the Bid Proposal, prior to the Bid Opening. Requests for qualification for Residents Contractor's Preference after Bid Opening will not be considered.

WAGE RATES:

It is the Contractor's responsibility to be acquainted with and comply with State Regulations regarding payment of wages on public projects. Wage rates as established by the New Mexico State Labor and Industrial Commission shall be paid by the contractor. Compliance is a part of this bid. Refer to Article 15 of the Supplementary Conditions.

REGISTRATION OF CONTRACTORS AND SUBCONTRACTORS:

It is the Bidder's responsibility to provide proof of compliance with the requirements for registration of Contractors and Subcontractors, according to the New Mexico Public Works Minimum Wage Act, for the Labor Enforcement Fund. Proof of compliance shall be provided to the Architect and the Owner prior to bid award.

END OF SECTION

**2004 Building Program
Western Heritage Center and Ben Alexander Student Learning Center
New Mexico Junior College, Hobbs, New Mexico**

SECTION 00320 - GEOTECHNICAL DATA

PART 1 - GENERAL

1.1 INVESTIGATION

- A. A geotechnical investigation was conducted at the site, the results of which are to be found following this Section.
- B. These data are for information only and not intended as representations or warranties of continuity of conditions at the site. The Owner and Architect do not warrant these data and interpretations of the data for accuracy, true location, and extent. Bidders and the Contractor are required to interpret these data, and make additional geotechnical investigations as they determine necessary, for the proper execution of the work.

PART 2 - PRODUCTS (Not Used)

PART 3 - EXECUTION (Not Used)

END OF SECTION

Geotechnical Report Follows

**2004 Building Program
Western Heritage Center and Ben Alexander Student Learning Center
New Mexico Junior College, Hobbs, New Mexico**

SECTION 00410 - BID FORM

BY (BIDDER) _____

(ADDRESS) _____

To **New Mexico Junior College** (hereinafter called "OWNER")

1. The undersigned (hereinafter called "Bidder") in compliance with your invitation for bids for the construction of the **Western Heritage Center and Ben Alexander Student Learning Center, New Mexico Junior College, Hobbs, New Mexico** having carefully examined the contract documents and the site of the proposed work, and being familiar with all conditions surrounding the construction of the proposed project including the availability of materials and labor, hereby proposes to furnish all labor, materials, and supplies, and to construct the project in accordance with the contract documents, within the time set forth herein, and at the lump sum prices stated below. These prices are to cover all expenses incurred in performing the work required under the contract documents of which this proposal is a part. All amounts shall be shown in both words and figures. In case of discrepancies, the amount shown in words will govern.

2. **Total Base Bid: Bid Lot 'A' and Bid Lot 'B' Combined:** Bidder agrees to perform the Work described as the Base Bid in the specifications and shown on the plans for the lump sum price of:
_____ (Dollars)(\$)
(not including NMGRT)(Reimbursement for NMGRT will be added on certificates for payment)
 - A. **Bid Lot 'A' of Base Bid – Western Heritage Center:** Bidder agrees to perform the Work described as the Base Bid in the specifications and shown on the plans for the lump sum price of:
_____ (Dollars)(\$)
(not including NMGRT)(Reimbursement for NMGRT will be added on certificates for payment)
 - B. **Bid Lot 'B' of Base Bid – Ben Alexander Student Learning Center:** Bidder agrees to perform the Work described as the Base Bid in the specifications and shown on the plans for the lump sum price of:
_____ (Dollars)(\$)
(not including NMGRT)(Reimbursement for NMGRT will be added on certificates for payment)

3. **Additive Alternate Number One:** Bidder agrees to perform the Work described as Alternate Number One in Section 01230 and shown on the plans for the lump sum price of:
_____ (Dollars)(\$)
(not including NMGRT)(Reimbursement for NMGRT will be added on certificates for payment)

4. **Additive Alternate Number Two:** Bidder agrees to perform the Work described as Alternate Number One in Section 01230 and shown on the plans for the lump sum price of:
_____ (Dollars)(\$)
(not including NMGRT)(Reimbursement for NMGRT will be added on certificates for payment)

5. **Additive Alternate Number Three:** Bidder agrees to perform the Work described as Alternate Number One in Section 01230 and shown on the plans for the lump sum price of:
_____ (Dollars)(\$)
(not including NMGRT)(Reimbursement for NMGRT will be added on certificates for payment)

6. **Additive Alternate Number Four:** Bidder agrees to perform the Work described as Alternate Number One in Section 01230 and shown on the plans for the lump sum price of:
_____ (Dollars)(\$)
(not including NMGRT)(Reimbursement for NMGRT will be added on certificates for payment)

7. **Additive Alternate Number Five:** Bidder agrees to perform the Work described as Alternate Number One in Section 01230 and shown on the plans for the lump sum price of:
_____ (Dollars)(\$)
(not including NMGRT)(Reimbursement for NMGRT will be added on certificates for payment)

8. **Additive Alternate Number Six:** Bidder agrees to perform the Work described as Alternate Number One in Section 01230 and shown on the plans for the lump sum price of: _____ (Dollars)(\$)
(not including NMGR)(Reimbursement for NMGR will be added on certificates for payment)
9. **Additive Alternate Number Seven:** Bidder agrees to perform the Work described as Alternate Number One in Section 01230 and shown on the plans for the lump sum price of: _____ (Dollars)(\$)
(not including NMGR)(Reimbursement for NMGR will be added on certificates for payment)
10. **Additive Alternate Number Eight:** Bidder agrees to perform the Work described as Alternate Number One in Section 01230 and shown on the plans for the lump sum price of: _____ (Dollars)(\$)
(not including NMGR)(Reimbursement for NMGR will be added on certificates for payment)
11. **Additive Alternate Number Nine:** Bidder agrees to perform the Work described as Alternate Number One in Section 01230 and shown on the plans for the lump sum price of: _____ (Dollars)(\$)
(not including NMGR)(Reimbursement for NMGR will be added on certificates for payment)
12. **Additive Alternate Number Ten:** Bidder agrees to perform the Work described as Alternate Number One in Section 01230 and shown on the plans for the lump sum price of: _____ (Dollars)(\$)
(not including NMGR)(Reimbursement for NMGR will be added on certificates for payment)
13. **Additive Alternate Number Eleven:** Bidder agrees to perform the Work described as Alternate Number One in Section 01230 and shown on the plans for the lump sum price of: _____ (Dollars)(\$)
(not including NMGR)(Reimbursement for NMGR will be added on certificates for payment)
14. **Addenda:** The undersigned hereby acknowledges receipt of the following addenda to the drawings and project manuals, all of the provisions and requirements of which addenda have been taken into consideration in the preparation of this proposal.
Addendum No. _____ Dated _____ Addendum No. _____ Dated _____
Addendum No. _____ Dated _____ Addendum No. _____ Dated _____
15. The undersigned declares that the only person or parties interested in the bid as principals are those named herein; that the bid is made without collusion with any firm or corporation; that he has carefully examined all contract documents and that he has made a personal examination of the site of the work; that he is to furnish all the necessary machinery, tools, apparatus and other means of construction, and that he will do all the work and furnish all the materials specified in the manner and the time prescribed.
16. The undersigned hereby agrees to execute the said contract and bond within ten (10) days, or such other time as may be allowed in writing by the Owner, after receiving notification of acceptance of bid. It is hereby mutually understood and agreed that in case the undersigned does not, he or she forfeits the accompanying check or bid bond to the Owner as liquidated damages, and said Owner may proceed to award the contract to others.
17. The undersigned hereby agrees to commence the work within ten (10) days or such further time as may be allowed in writing by the Owner after receiving notification of award of contract. The undersigned further agrees that all work items will be completed within 365 consecutive calendar days.
18. The undersigned proposes to furnish a bond in the sum of one hundred (100) percent of bid amount as surety conditioned for the full, complete and faithful performance of this contract, and to indemnify and save harmless the Owner from any damage or loss for which the Owner may become liable by the default of said contractor, or by reason of any neglect or carelessness on the part of said contractor, his agents or employees, or by or on account of any act of omission of said contractor, his servants, agents or employees, or subcontractors, in performance of this contract.
- A. The undersigned will guarantee all work performed under these plans, specifications and contract, and shall repair and maintain same until the date of acceptance by the Owner.
- B. The undersigned tenders herewith, as a bid guarantee, for which receipt has been given, a certified check or bid bond in the amount of five (5) percent of the bid amount drawn to the order of the Owner.
19. Bidder agrees that this Bid Proposal may not be withdrawn for a period of thirty (30) calendar days after the Bid Opening. If the contract is to be awarded, Owner will give the successful Bidder a Notice of Award within thirty (30) calendar days after the Bid opening.

20. The undersigned agrees within ten (10) days after the agreement is executed, to deliver to the Owner the certificates of insurance and original insurance policies required in the General Conditions.
21. The undersigned hereby agrees to pay the Owner the sum of Seven Hundred and Fifty Dollars (\$750) as liquidated damages for each consecutive calendar day of delay until the Work is substantially complete.
22. Attached is the required Bid Security and List of Subcontractors. If requested, Bidder agrees to furnish to Owner all information and data necessary for Owner to determine the qualifications and ability of Bidder to perform the Work, including a Contractor's Qualification Statement (such as AIA Document A305).
23. Bidder certifies that proof of compliance with the requirements for registration of Contractors and Subcontractors, according to the New Mexico Public Works Minimum Wage Act, for the Labor Enforcement Fund, will be provided to the Architect and the Owner prior to bid award.
24. This Bid Proposal is hereby respectfully submitted. The signatory hereto certifies and warrants that he/she has full authority to submit this Bid Proposal on behalf of Bidder.

 (Name of Bidder)(Type or Print)(Specify if sole proprietorship, partnership, or corporation, and state of incorporation)

 By (Signature)

 Date
 Corporate Seal:

 (Name)

 (Title)(Print Name & Title of Bidder's Authorized Representative)

 (Address of Bidder)

 (Bidder's New Mexico Contractor's License No. and Classification)

 (Telephone Number of Bidder)

END OF SECTION

**2004 Building Program
Western Heritage Center and Ben Alexander Student Learning Center
New Mexico Junior College, Hobbs, New Mexico**

SECTION 00430 - LIST OF SUBCONTRACTORS RESIDENT BIDDER PREFERENCE

FOR COMPLIANCE WITH SUBCONTRACTORS FAIR PRACTICES ACT (SECTION 00431)

It is the Bidder's sole responsibility to execute this listing in compliance with the New Mexico Subcontractor's Fair Practices Act. The following listing must include the NAME, LOCATION OF PLACE OF BUSINESS, PHONE NUMBER, CONTRACTOR'S LICENSE NUMBER, and CATEGORY OF WORK which will be done by each subcontractor on the list. List only one subcontractor for each category of work, FAILURE TO COMPLY WITH THESE REQUIREMENTS WILL MAKE THE BID NON-RESPONSIVE and the bid will be rejected. This page shall be attached to the Bid Proposal.

The Bidder must list all Subcontractors to be used for work, when the subcontract amount exceeds the threshold amount of \$27,500.

(Use additional sheets if necessary).

NAME OF SUBCONTRACTOR AND LOCATION OF PLACE OF BUSINESS	CATEGORY OF WORK OF SUBCONTRACTOR
(Name)	(Category)
(Location & Phone No.)	
(License No.)	
(Name)	(Category)
(Location & Phone No.)	
(License No.)	
(Name)	(Category)
(Location & Phone No.)	
(License No.)	
(Name)	(Category)
(Location & Phone No.)	
(License No.)	
(Name)	(Category)
(Location & Phone No.)	
(License No.)	

**NAME OF SUBCONTRACTOR AND
LOCATION OF PLACE OF BUSINESS**

**CATEGORY OF WORK
OF SUBCONTRACTOR**

(Name) (Category)

(Location & Phone No.)

(License No.)

(Name) (Category)

(Location & Phone No.)

(License No.)

(Name) (Category)

(Location & Phone No.)

(License No.)

(Name) (Category)

(Location & Phone No.)

(License No.)

(Name) (Category)

(Location & Phone No.)

(License No.)

(Name) (Category)

(Location & Phone No.)

(License No.)

(Name) (Category)

(Location & Phone No.)

(License No.)

(Name) (Category)

(Location & Phone No.)

(License No.)

RESIDENT BIDDER PREFERENCE

New Mexico procurement law provides for a five percent (5%) residential preference. A fully qualified bidder who meets state requirements shall be awarded a contract in preference to a fully qualified non-resident bidder whenever the resident bidder, whose bid is nearest to the low bid of the non-residential bidder, is made lower when multiplied by a factor of 0.95. This does not apply when federal funds are being used. Any New Mexico firm claiming preference will insert the residential preference number as issued by the State Purchasing Department in the appropriate space as provided in the bid documents. Procurement of the number is the responsibility of the bidder.

Note that there is no charge for the number, but it does involve an application process.

Interested bidders should contact:

State of New Mexico
General Services Department
Purchasing Division
Joseph M. Montoya State Building, Room 2016
1100 St. Francis Drive
Santa Fe, New Mexico 87502
Telephone: (505) 827-0472

END OF SECTION

**2004 Building Program
Western Heritage Center and Ben Alexander Student Learning Center
New Mexico Junior College, Hobbs, New Mexico**

SECTION 00431 - SUBCONTRACTORS FAIR PRACTICES ACT

This Public Works Project is subject to the provisions of the Subcontractors Fair Practices Act (Chapter 18, Laws of 1988; Section 13-4-31 through 13-4-43 NMSA 1978).

- A. The listing threshold is: \$27,500.
- B. List of Subcontractors Required: The Bidder shall define the categories of subcontractors in the bid and shall list on Page 00430-1, no more than one subcontractor for each such category, PROVIDED HOWEVER, that such listing shall not include subcontractors whose work does not exceed the threshold dollar amount given in subparagraph A, above. Such list shall give the name of each subcontractor under subcontract to the Bidder who will perform work or labor or render service to the Bidder in an amount exceeding the threshold stated in subparagraph A.
- C. All subcontractors whose estimated work exceeds the threshold shall be listed at the time the Bid is submitted to OWNER.
- D. The apparent low Bidder may allow a subcontract that exceeds the threshold amount to be voluntarily assigned or transferred or to be performed by anyone other than the original subcontractor listed in the original bid, only if the OWNER gives prior written approval.
- E. No Bidder whose Bid is accepted shall sublet or subcontract any portion of the Work in an amount exceeding the threshold amount given in subparagraph A, above, where the original bid did not designate a subcontractor, unless:
 - 1) The Bidder received no bid for that category (note: the Bidder must designate on the list of subcontractors required in subparagraph B., above, that "no bid was received"), or
 - 2) The Work is pursuant to a Change Order that causes changes or deviations from the original Contract.
- F. Delays Attributable to Hearings Required by the Subcontractors Fair Practices Act: In the event a hearing is required pursuant to the provisions of the Subcontractors Fair Practices Act and a delay in the Work is caused as a result of a subcontractor protesting its substitution, the CONTRACTOR shall not be entitled to an increase in the Contract Price or Contract Time.
- G. Applicability of Section: This section shall apply to: (ONLY ONE will be checked as applicable to this Project)

- 1) All work required of the CONTRACTOR
- 2) Only the following work required of CONTRACTOR (list areas):

- 3) All work required of CONTRACTOR except (list areas):

END OF SECTION

**2004 Building Program
Western Heritage Center and Ben Alexander Student Learning Center
New Mexico Junior College, Hobbs, New Mexico**

SECTION 00432 - MINIMUM WAGE RATES

The New Mexico State Minimum Wage Rates applicable for this Contract, as evidenced by the attached determination by the New Mexico Labor and Industrial Commission, shall be paid to all workers employed in the performance of the work. See Article 15, Supplementary Conditions.

END OF SECTION

(Wage Rates to Follow)

**2004 Building Program
Western Heritage Center and Ben Alexander Student Learning Center
New Mexico Junior College, Hobbs, New Mexico**

SECTION 00500 - OWNER/CONTRACTOR AGREEMENT

The form of Owner/Contractor Agreement to be executed is AIA Document A101, 1997 Edition or current edition.

END OF SECTION

**2004 Building Program
Western Heritage Center and Ben Alexander Student Learning Center
New Mexico Junior College, Hobbs, New Mexico**

SECTION 00700 - GENERAL CONDITIONS

The General Conditions of this Contract shall be A.I.A. Document A201, 1997 edition or current edition, "General Conditions of the Contract for Construction," and is hereby made a part of the Contract Documents by reference.

END OF SECTION

**2004 Building Program
Western Heritage Center and Ben Alexander Student Learning Center
New Mexico Junior College, Hobbs, New Mexico**

SECTION 00800 - SUPPLEMENTARY GENERAL CONDITIONS

THE "GENERAL CONDITIONS OF THE CONTRACT FOR CONSTRUCTION", AIA DOCUMENT A201, 1997 EDITION, ARTICLES 1 THROUGH 14 INCLUSIVE, IS HEREBY MADE PART OF THE SPECIFICATIONS THE SAME AS IF REPRODUCED HERE, IN FULL, EXCEPT AS MODIFIED, RESCINDED OR SUPPLEMENTED BY THESE SUPPLEMENTARY CONDITIONS, WHICH TAKE PRECEDENCE. THOSE PORTIONS OF THE GENERAL CONDITIONS THAT ARE NOT ALTERED BY THESE SUPPLEMENTARY CONDITIONS SHALL REMAIN IN FORCE AND EFFECT AS PUBLISHED. COPIES OF THE GENERAL CONDITIONS MAY BE EXAMINED AT THE OFFICES OF THE ARCHITECT, OR MAY BE PURCHASED AT NOMINAL CHARGE FROM THE AMERICAN INSTITUTE OF ARCHITECTS, 1735 NEW YORK AVENUE NW, WASHINGTON, D.C. 20006.

ARTICLE 1 GENERAL PROVISIONS:

1.1 DEFINITIONS:

At the end of paragraph 1.1.1, add the following sentence:
The Form of the Agreement between Owner and Contractor shall be the American Institute of Architects Document A101, 1997 edition.

1.2 CORRELATION AND INTENT OF THE CONTRACT DOCUMENTS:

Add the following 1.2.1:

1.2.1 In case of conflicts or discrepancies between the Drawings, between Drawings and Specifications, and between the various requirements of the Specifications, or within or between any documents pertaining to the Work, the Architect will determine which document or part takes precedence in accordance with paragraph 4.2.11. In general, but not without exception, at the sole discretion of the Architect, the more stringent or higher cost requirement is required. Submit a Request For Information (RFI) to the Architect for an interpretation of the requirements prior to proceeding with any Work associated with conflicts or discrepancies between the Drawings, between Drawings and Specifications, and between the various requirements of the Specifications, or within or between any documents pertaining to the Work.

1.6 OWNERSHIP AND USE OF DRAWINGS, SPECIFICATIONS, AND OTHER INSTRUMENTS OF SERVICE

Add the following 1.6.2:

1.6.2 CONTRACTOR'S USE OF INSTRUMENTS OF SERVICE IN ELECTRONIC FORMAT

1.6.2.1 At the request of the Contractor, Architect, at Architect's sole discretion, may furnish to the Contractor versions of the Instruments of Service in electronic format. The Contract Documents executed or identified in accordance with subparagraph 1.5.1 shall prevail in case of an inconsistency with subsequent versions made through electronic manipulation by computer.

1.6.2.2 Owner and Contractor shall sign a CAD File Release and Indemnity, in a format as presented by the Architect, prior to transmission of any electronic format files to the Contractor. No files will be transmitted for use to the Contractor without Owner's and Contractor's signatures on the form. Contractor may be required to sign CAD File Release and Indemnity, or similar, forms for Design Consultant files, in addition to the Architect's form.

1.6.2.3 The Contractor shall not transfer or reuse Instruments of Service in electronic format or machine readable form without prior written consent of the Architect.

1.6.2.4 The Owner and Contractor agree that upon signature, the conditions of use contained on the Architect's CAD File Release and Indemnity form are binding as if included in the Contract.

- 1.6.2.5 CAD File requests shall be made sufficiently in advance of Contractor's intended use of the files to allow Architect a minimum of 10 working days to prepare files for release to Contractor.
- 1.6.2.6 Contractor shall pay to Architect \$100.00 fee for each CAD File request, payable in advance of transfer of any file to Contractor by Architect. Contractor may be required to pay additional fees for Design Consultant CAD file requests.

ARTICLE 2 OWNER:

2.2 INFORMATION AND SERVICES REQUIRED OF THE OWNER:

Delete paragraph 2.2.5, and substitute the following:

- 2.2.5 The Contractor will be furnished free of charge 10 copies of Drawings and Project Manuals. Additional sets will be furnished at the cost of reproduction, postage and handling.

Add subparagraph 2.2.6, as follows:

- 2.2.6 The Owner will procure and bear the costs of structural test and special inspections as required by the applicable building code.

ARTICLE 3 CONTRACTOR:

Add the following subparagraph 3.2.4:

- 3.2.4 The Owner shall be entitled to deduct from the Contract Sum, by Change Order, amounts paid to the Architect for the Architect to evaluate and respond to the Contractor's requests for information, where such information was available to the Contractor from careful study and comparison of the Contract Documents, field conditions, other information previously provided by the Owner or Architect, Contractor prepared coordination drawings, or prior Project correspondence or documentation.

3.4 LABOR AND MATERIALS:

To paragraph 3.4.1, add the following new sub-paragraphs 3.4.1.1 and 3.4.1.2:

- 3.4.1.1 Not later than 20 days from the Contract Date, the Contractor shall provide a list of the names of the manufacturers proposed to be used and, where applicable, the name of the installer. This list supplements and expands the Subcontractor List submitted with the Bid Form.

- 3.4.1.2 The Architect will promptly reply in writing to the Contractor stating whether the Owner or the Architect has objection to any such entity. If adequate data on any proposed manufacturer or installer is not available, the Architect may state that action will be deferred until the Contractor provides further data. Failure of the Owner or the Architect to reply promptly shall not constitute a waiver of any of the requirements of the Contract Documents and all products furnished by the listed manufacturer must conform thereto.

Add the following 3.4.3.1:

- 3.4.3.1 No alcoholic beverage is permitted on the project site. No non-prescription drugs are permitted. No firearms or regulated weapons are permitted.

3.6 TAXES:

Add new paragraphs 3.6.2 and 3.6.3 as follows:

3.6.2 The Contract Sum excludes the applicable New Mexico gross receipts tax or applicable local option tax, but the Contractor shall be required to collect from the Owner and to pay the applicable tax including any increase or decrease in the applicable tax becoming effective after the date the contract is entered into.

3.6.3 Applicable gross receipts tax or applicable local option tax shall be shown as a separate amount on each billing or request for payment made by the Contractor. The Contractor shall present a separate invoice to the Owner for payment of applicable taxes with each application for payment.

3.7 PERMITS, FEES AND NOTICES:

Add the following to 3.7.1:

The Contractor shall secure, arrange, and pay for all necessary utility extensions and connections. Contact utility companies including gas, electric, sewer, storm drainage, water, telephone, cable, data, and others to verify, coordinate and pay for costs associated with service providers including but not limited to expansion charges, service lines, equipment, connection fees, routing to required service connection locations, service line installations, trenching for utility installation, and piping, conduits, fittings and testing for all utilities. Coordinate and provide complete and operable utility services and forward all service agreements requiring signature by others to the Owner.

Add the following to 3.7.2:

In addition to other agencies that require notices, the Contractor is required to pay all fees and submit a *Notice of Intent to Discharge* and file a *Storm Water Pollution Prevention Plan* and obtain a permit for all site disturbances of 5 acres or more with the:

U.S. Environmental Protection Agency
1200 Pennsylvania Avenue, NW
Washington DC 20460
<http://www.epa.gov/> New Mexico is in Region 6.

A local contact to assist with questions is:

NM Environmental Dept.
Box 26110
Santa Fe, NM 87502
505-827-2827

3.8 ALLOWANCES:

3.8.2.2 Delete the semicolon at the end of 3.8.2.2 and add the following:
“, except that if installation is included as part of an allowance, the installation and labor cost for greater or lesser quantities of Work shall be determined in accordance with Subparagraph 7.3.6;”

3.9 SUPERINTENDENT:

Add to 3.9.1 as follows:

At any time, when any Work is proceeding at the project site, including after normal hours or on weekends, the Contractor’s Superintendent and necessary assistants shall be present at the site.

Add new paragraphs 3.9.2 as follows:

3.9.2 Selection of the Superintendent by the Contractor shall be subject to approval by the Owner as provided in this paragraph. The individual who becomes Superintendent at the Commencement of the Work shall remain Superintendent throughout the course of the Work unless the Owner

requests that the Superintendent be replaced or the Superintendent ceases to be employed by the Contractor.

3.9.2.1 Upon execution of the Owner-Contractor Agreement, the Contractor shall give the Owner written notice of the identity, resume, and qualifications (including a list of prior projects on which employed) of the person proposed by the Contractor for the position of Superintendent. If the Owner gives oral or written notice to the Contractor within seven (7) days thereafter that the person proposed is unacceptable for any reason, the Contractor shall name and state the qualifications of an alternate who shall be subject to approval in a like manner. This procedure shall be repeated until the Owner expresses no objection to the Contractor's proposed Superintendent.

3.9.2.2 The Contractor shall not assign the duties of Superintendent to any person who has not been approved in this manner. If, during the course of the Work, the Owner gives notice in writing to the Contractor that the person serving as Superintendent has become unacceptable for any reason the Contractor shall within fifteen (15) days thereafter name and state the qualifications of a replacement who shall be subject to approval as provided above. If the Superintendent is to be replaced at the request of the Contractor (such as in the case of the Superintendent's resignation or discharge from employment by the Contractor), the Contractor shall give the Owner notice in advance of its intention to replace the Superintendent, the reasons therefore, and the identity and qualifications of the proposed replacement, who shall be subject to approval as provided above.

3.9.2.3 The Owner shall not have control over, and shall not be deemed to have control over, the acts or omissions to act of the Superintendent. The Superintendent remains an employee of the Contractor, subject only to the Owner's right to approve of the identity of the person occupying the position.

3.10 CONTRACTOR'S CONSTRUCTION SCHEDULES:

Add new paragraph 3.10.1.1 as follows:

3.10.1.1 The Owner may authorize construction activities to commence prior to completion of the Drawings and Specifications. If the Drawings and Specifications require further development at the time that the initial Construction Schedule is prepared, the Contractor shall 1) allow time in the schedule for development of the Drawings and Specifications by the Architect, including time for review by the Owner and Contractor and for the Contractor's coordination of Subcontractors' Work, and 2) furnish to the Owner in a timely manner information regarding anticipated market conditions and Construction cost; availability of labor, materials, and equipment; and proposed methods, sequences, and time schedules for Construction of the Work.

3.12 SHOP DRAWINGS, PRODUCT DATA AND SAMPLES:

Add to 3.12.8 as follows:

Architect's notations on approved submittals have the same effect as an Architect's Supplemental Instruction or Minor Change in The Work under Article 7.4. Make revisions noted. Notify Architect in writing if noted modifications cannot be made due to conflicting circumstances in the field, in other contract documents, or for other reasons. If the Contractor believes that the Architect's notations constitute a change that results in added cost or time, notify the Architect in writing within the time limits of Article 4.3. Do not proceed with changes that result in added cost or time until the matter is resolved in accordance with other provisions of the contract.

Add subparagraph 3.12.11 to paragraph 3.12, as follows:

3.12.11 The Architect's review of Contractor's submittals will be limited to examination of an initial submittal and one resubmittal. Architect's review of additional submittals, due to Contractor's errors or omissions in the initial and one resubmittal, will be made only with the consent of the

Owner, after notification by the Architect to the Owner and Contractor. The Owner shall be entitled to deduct from the Contract Sum, by execution of a Change Order, amounts paid to the Architect for evaluation of additional submittals.

3.18 **INDEMNIFICATION:**

Add new paragraphs 3.18.3 and 3.18.4 as follows:

3.18.3 Agreement of the Contractor to indemnify the Owner under this paragraph 3.18 shall not extend to liability, claims, damages, losses, or expenses, including attorney fees, arising out of bodily injury to persons or damage to property which in turn arise out of:

- A. The preparation or approval of maps, drawings, opinions, reports, surveys, change orders, designs, or specifications by the Owner or its agents or employees; or
- B. The giving of or the failure to give directions or instructions by the Owner or its agents or employees, where such giving or failure to give directions or instructions is the primary cause of bodily injury to persons or damage to property.

3.18.4 The Contractor shall indemnify and save the Owner harmless from any loss, liability, and expense, including attorney fees, which result from any claimed irregularity in the awarding of the Contract, which irregularity is, in whole or in part, the Contractor's fault.

ARTICLE 4 **ADMINISTRATION OF THE CONTRACT:**

4.2 **ARCHITECT'S ADMINISTRATION OF CONTRACT:**

Add to paragraph 4.2.2 the following 4.2.2.1:

4.2.2.1 The Contractor shall reimburse the Owner for compensation paid to the Architect for additional site visits made necessary by the fault, neglect, or request of the Contractor. A Change Order reducing the Contract Sum will be executed.

4.2.10 Delete from paragraph 4.2.10 the second sentence in its entirety.

4.2.13 Add to paragraph 4.2.13 the following sentences:

The term "aesthetic effect" refers, but is not limited, to color, texture, profile, and relationship of masses. The Architect shall be the sole interpreter of the design intent with respect to such matters, but the Architect's authority with respect thereto shall not contravene any other rights of either the Owner or the Contractor ascribed to them by other provisions of the contract.

4.3 **CLAIMS AND DISPUTES:**

4.3.2 **TIME LIMITS ON CLAIMS:**

Change "21 days" to "7 days", in both occurrences.

4.3.7 **CLAIMS FOR ADDITIONAL TIME:**

Add to sub-paragraph 4.3.7.2 as follows:

Normal and reasonably anticipated weather at the project site includes severe conditions, including, but not limited to: strong sustained winds and gusty winds, violent thunderstorms, heavy rains, heavy snowfall, icing, periods of high and low humidity, periods of severe heat and cold, and dramatic, abrupt changes in conditions. Extensions in time for weather delays will only be granted for conditions exceeding such normal weather for the area, based on independent weather agency records for the area of the Project site. Severe weather that exceeds the weather normally predictable (record setting conditions) for the duration of the Contract shall be considered unusually inclement weather.

Add sub-paragraphs 4.3.7.3, 4.3.7.4, 4.3.7.5, and 4.3.7.6 as follows:

- 4.3.7.3 No payment or compensation of any kind, other than an authorized extension of time where applicable, shall be made to the Contractor for any Excusable Delay. Excusable Delay is defined as any event that delays the work of the critical path that is beyond the control and without the fault or negligence of the Contractor or Owner; caused by events or circumstances such as acts of God, acts of the public enemy, intervention of another entity not a part of this Contract, acts of the government other than the Owner, fires, floods, and unusually inclement weather as defined in 4.3.7.2.
- 4.3.7.4 No compensation of any kind shall be made for an Inexcusable Delay. Inexcusable Delay is defined as a delay caused by events or circumstances within the control of the Contractor, such as, but not limited to: inadequate crewing, inadequate equipment, inadequate supervision, slow submittals or late ordering of materials, failure to coordinate the work, etc.; which may have been avoided by the exercise of care, prudence, foresight, proper planning, or due diligence on the part of the Contractor. The Contractor shall correct any condition causing an Inexcusable Delay as required to achieve Substantial Completion within the Contract Time.
- 4.3.7.5 All claims for extension of time and/or increased compensation shall be made in writing to the Architect no more than seven (7) calendar days after the occurrence of the event causing the delay; otherwise, they shall be permanently waived by the Contractor. Claims for increase in the Contract Time shall set forth in detail the circumstances that form the basis of the claim, the date upon which each cause of delay began to affect the progress of the Work, initial estimate of the probable affect of delay on the progress of the Work, the date upon which each cause of delay ceased to affect the progress of the Work, and the number of days increase in the Contract Time claimed as a consequence of each cause of delay. The Contractor shall supply such supporting documentation as the Owner may require, including, but not limited to, where appropriate, a revised construction schedule indicating all of the activities affected by the circumstances forming the basis of the claim for delay.
- 4.3.7.6 The Contractor shall not be entitled to a separate increase in the Contract Time or compensation for each one of the number of causes of delay which may have concurrent or interrelated effects on the progress of the Work, or any cause of delay that is concurrent with an Inexcusable Delay.
- 4.3.10 CLAIMS FOR CONSEQUENTIAL DAMAGES:
Add the following sentence to 4.3.10:
- If, before expiration of 30 days from the date of execution of this Agreement, the Owner obtains by separate agreement and furnishes to the Contractor a similar mutual waiver of all claims from the Architect against the Contractor for consequential damages which the Architect may incur as a result of any act or omission of the Owner or Contractor, then the waiver of consequential damages by the Owner and Contractor contained in this subparagraph 4.3.10 shall be applicable to claims by the Contractor against the Architect.
- 4.6 ARBITRATION:
To paragraph 4.6.2, add the following new sub-paragraphs 4.6.2.1 thru 4.6.2.3:
- 4.6.2.1 At the Owner's option, paragraph 4.6.1, shall not apply to a claim by the Owner against the Contractor arising under paragraph 3.18 (Indemnification) of Contract.
- 4.6.2.2 The reasonable cost of the arbitration proceeding (including attorney and arbitrator's fees) shall be borne by the non-prevailing party as determined by the arbitrators.
- 4.6.2.3 There shall be three neutral arbitrators, unless the Owner and Contractor specifically agree otherwise in a subsequent writing. The Owner shall select one arbitrator. The Contractor shall

select one arbitrator. The third arbitrator shall be a New Mexico attorney experienced in construction law and shall be selected by the first two arbitrators. Reasonable discovery shall be permitted, in the sound discretion of the arbitrators. The arbitration hearing shall be transcribed, and the arbitrators shall be required to make written findings and conclusions.

ARTICLE 5 SUBCONTRACTORS:

5.2 AWARD OF SUBCONTRACTS AND OTHER CONTRACTS FOR PORTIONS OF THE WORK:

Delete paragraphs 5.2.1, 5.2.2, 5.2.3, and 5.2.4 in their entirety and substitute the following:

5.2.1 Contractor shall make no substitution of subcontractors or principal suppliers identified in the list of subcontractors submitted with the bid unless specifically authorized to do so in advance, in writing, by the Owner and the Architect, and only in accordance with New Mexico Subcontractors Fair Practices Act (NMSFPA). Such authorization will be granted or withheld in the sole discretion of the Owner and Architect.

5.2.2 If replacement of a subcontractor identified in the list of subcontractors becomes necessary due to circumstances beyond the Contractor's control and if the Owner and Architect approve such replacement in writing and authorized by NMSFPA, Contractor shall name the proposed replacement. The replacement shall be subject to approval by the Owner and Architect after reasonable notice. If the proposed replacement is not acceptable to Owner or Architect, this process shall be repeated until the Owner and Architect approve Contractor's proposed replacement.

5.2.3 Cost arising from replacement of subcontractor shall be borne entirely by Contractor.

5.3 SUBCONTRACTUAL RELATIONS

Add the following 5.3.2:

5.3.2 In accordance with the New Mexico Retainage Act, the Contractor and Subcontractors shall provide payments to their subcontractors and suppliers for amounts owed for materials delivered and for Work performed on the Project within seven days after receipt of payment from the Owner, Contractor, or Subcontractor. If the Contractor or Subcontractor fails to make prompt payment, the Contractor or Subcontractor shall pay interest beginning on the eighth day at the rate of one and one half percent of the undisputed amount per month or fraction of a month until payment is made. These provisions apply to all tiers of subcontracts and suppliers.

ARTICLE 7 CHANGES IN THE WORK:

7.2 CHANGE ORDERS:

Delete paragraph 7.2.2 in its entirety and substitute the following:

7.2.2 No changes in the Work shall be made without having prior written approval of the Owner and Architect. Charges or credits for the Work, covered by Change Order, shall be determined by one, or a combination of any, of the following methods, as Architect judges appropriate:

1. Unit bid prices previously approved.
2. An agreed lump sum based on an itemized estimate of the cost.
3. Time and Materials based on the actual cost of:
 - a. Labor and payroll for changed work, including supervision and foreman;
 - b. Labor Burden fixed at 31% applied to labor costs including Workmen's Compensation and Liability Insurance, Employment Taxes under FICA/Medicare, SUTA and FUTA, Vacation / Holiday and other labor burden;
 - c. Invoiced cost of materials entering permanently into the work;

- d. Actual invoiced cost of fair rental value of construction equipment during the time of use on the extra work.
- e. Invoiced cost of power and consumable supplies for the operations of power equipment;
- f. Overhead and Profit which shall not exceed limits and tiers set forth below:

ALLOWABLE OVERHEAD AND PROFIT

	<u>\$500 and less</u>	<u>\$500 to \$5,000</u>	<u>Over \$5,000</u>
Contractor for work performed by his own forces	25%	20%	15%
Subcontractor for work performed by his own forces	25%	20%	15%
Contractor for work performed by subcontractor	10%	8%	6%

For work exceeding \$50,000, the Overhead and Profit values will be subject to negotiation between the Owner and Contractor.

- g. On change orders covering both increases and decreases in the amount of the contract, the combined overhead and profit shall be allowed on the net increase, or decrease, only.
- h. Apply the New Mexico and local Gross Receipts Tax to the sub-total cost.
- i. Adjustment, if any, in the Contract Time.

Add paragraphs 7.2.3 and 7.2.4 as follows:

7.2.3 In response to each Proposal Request (PR) for a change in the amount of the Contract, the Contractor shall submit, within 15 days of the date of the PR, an itemized Cost Proposal showing the estimated cost of the items described in paragraph 7.2.2.3. No Change Order will be approved without an itemized Cost Proposal from the Contractor. Contractor shall review and certify each Cost Proposal from a subcontractor or other entity for completeness, accuracy, and validity prior to submittal to the Architect.

7.2.4 The Architect's review of Contractor's Cost Proposals will be limited to examination of an initial submittal and one resubmittal. Architect's review of additional submittals, due to Contractor's errors or omissions in the initial and one resubmittal, will be made only with the consent of the Owner, after notification by the Architect to the Owner and Contractor. The Owner shall be entitled to deduct from the Contract Sum, by execution of a Change Order, amounts paid to the Architect for evaluation of additional submittals.

7.3 **CONSTRUCTION CHANGE DIRECTIVES:**
Delete sub-paragraph 7.3.3.4 entirely and substitute the following:

7.3.3.4 as provided in paragraph 7.2.2.

Delete paragraph 7.3.6 and sub-paragraphs 7.3.6.1, 7.3.6.2, 7.3.6.3, 7.3.6.4, and 7.3.6.5 in their entirety and substitute the following:

7.3.6 If the Contractor does not respond promptly, or disagrees with the method of adjustment in the contract sum proposed by the Architect, payments shall be made on Architect's certificate for payment on the basis of Architect's method of adjustment pending Architect's final determination of cost to Owner.

ARTICLE 8 TIME:

8.1 DEFINITIONS

Add new paragraph 8.1.5 as follows:

8.1.5 The Contract Time shall expire at midnight on the 365 CALENDAR day from the date of the Notice To Proceed.

8.3 DELAYS AND EXTENTIONS OF TIME:
Delete paragraph 8.3.3 in its entirety.

ARTICLE 9 PAYMENTS AND COMPLETION:

9.3 APPLICATIONS FOR PAYMENT:

9.3.1 Change “ten days” to “45 days if Notice of Extended Payment Provision is given under Article 9.6.8, and affixed to all of the plans”.

In the last sentence of 9.3.1, after the word “suppliers”, change the comma to a period, and delete the words, “and reflecting retainage if provided for in the Contract Documents.” Add the following sentence to 9.3.1: “No retainage will be held from payments to the Contractor.”

9.6 PROGRESS PAYMENTS:

9.6.1 Change “the time provided in the Contract Documents” to “45 days after the Architect receives the undisputed Application For Payment unless Notice of Extended Payment Provisions is given under Article 9.6.8, and affixed to all of the plans.

9.6.2 Add the sentence: Payments by the Contractor and Subcontractors to Subcontractors and suppliers shall be according to the requirements of 5.3.2 as modified by these Supplementary Conditions.

9.7 FAILURE OF PAYMENT:

9.7.1 Change “seven days after the date established in the Contract Documents” to “the time required in 9.6.1 or 9.6.8 (if 9.6.8 is included).”

9.8 SUBSTANTIAL COMPLETION:

Add 9.8.3.1 as follows:

9.8.3.1 Except with the consent of the Owner and notification to the Contractor, the Architect will perform no more than two inspections to determine whether the Work, or a designated portion of the Work, has attained Substantial Completion in accordance with the Contract Documents. The Owner shall be entitled to deduct from the Contract Sum amounts paid to the Architect for any additional inspections due to the Contractor’s failure to attain Substantial Completion at the time indicated in the Contractor’s requests for Substantial Completion inspection.

9.8.5 Delete the second and third sentences in their entirety.

9.9 PARTIAL OCCUPANCY FOR USE:

9.9.1 In the second sentence, delete the words, “retainage, if any,”.

9.10 FINAL COMPLETION AND FINAL PAYMENT:

Add 9.10.1.1 as follows:

9.10.1.1 Except with the consent of the Owner and notification to the Contractor, the Architect will perform no more than two inspections to determine whether the Work, or a designated portion of the Work, has attained Final Completion in accordance with the Contract Documents. The Owner shall be entitled to deduct from the Contract Sum amounts paid to the Architect for any additional inspections due to the Contractor’s failure to attain Final Completion at the time indicated in the Contractor’s requests for Final Completion inspection.

9.10.2 Revise the first part of the first sentence to read: "Final payment shall not become due until..." The remainder of the text shall remain unchanged.

Add new paragraph 9.11 as follows:

9.11 LIQUIDATED DAMAGES:

9.11.1 The Owner will suffer financial and other loss if the project is not substantially completed on the date set forth in the Contract Documents. The Contractor, and the Contractor's surety, shall be liable for, and shall pay to the Owner, \$750 dollars as liquidated damages for each calendar day of delay after the date established for Substantial Completion in the Contract Documents, until date that the Work is certified as substantially complete by the Architect.

ARTICLE 11 INSURANCE AND BONDS:

11.1 CONTRACTORS LIABILITY INSURANCE:

11.1.1.1 Delete the semicolon at the end of the sentence and add:

" , including private entities performing Work at the site and exempt from the coverage on account of number of employees or occupation, which entities shall maintain voluntary compensation coverage at the same limits specified for mandatory coverage for the duration of the Work performed by the entities at the site;"

11.1.1.2 Delete the semicolon at the end of the sentence and add:

"or persons or entities excluded by statute from the requirements of 11.1.1.1 but required by the Contract Documents to provide the insurance required by 11.1.1.1;"

11.1.2 In the first sentence after the word "written," delete the rest of the sentence and replace with the following:

"under insurance forms providing coverage of not less than that set forth as follows, or greater if required by law."

Contractor's automobile liability insurance shall be written under a Business Auto form including coverage for owned, non-owned and hired vehicles. Contractor's general liability insurance shall be written under a Commercial General Liability form including Owner's and Contractor's Protective coverage, Premises-Operations coverage, Products-Completed Operations coverage, X, C, and U coverage, and Contractual Liability coverage specifically including Contractor's liability to Owner under paragraph 3.18 (Indemnification). All liability insurance shall be written on an occurrence basis. The limits of Contractor's liability insurance shall be not less than the following:

Compensation and Liability

Worker's Compensation	Statutory
Employer's Liability	\$100,000.00
Automobile Liability	\$1 million combined single limit
Commercial General Liability	\$1 million combined single limit
Contractual Liability	\$1 million combined single limit

11.1.3 At the end of paragraph 11.1.3, add the following sentence:

If this insurance is written on a Commercial General Liability policy form, the certificates shall be ACORD form 25-S, completed and supplemented in accordance with AIA Document G715, Instruction Sheet and Supplemental Attachment for ACORD Certificate of Insurance 25-S.

11.5 PERFORMANCE BOND AND PAYMENT BOND:

Delete 11.5.1 and substitute:

11.5.1 The Contractor shall furnish bonds covering the faithful performance of the Contract and payment obligations arising thereunder. The cost of bonds shall be included in the Contract Sum. The amount of each bond shall be equal to 100% of the Contract Sum.

11.5.1.1 The Contractor shall deliver the required bonds to the Owner no later than three days following the date that the Agreement is entered into, or if the Work is to be commenced prior to the date of the Agreement in response to a letter of intent from the Owner, the Contractor shall, prior to commencement of the Work, submit evidence satisfactory to the Owner that such bonds will be furnished. In no case shall the bonds be delivered to the Owner later than three days following commencement of the Work.

11.5.1.2 The Contractor shall require the attorney-in-fact who executes the required bonds on behalf of the surety to affix a certified and current copy of the power of attorney.

11.5.1.3 The surety providing the Bonds must be authorized to do business in the State of New Mexico, and must be approved in federal circular 570 as published by the U.S. Treasury Department. Failure to furnish Bonds in strict compliance with these requirements is grounds for disqualification of the Contractor and forfeiture of bid security.

ARTICLE 12 UNCOVERING AND CORRECTION OF WORK:

12.2.2 AFTER SUBSTANTIAL COMPLETION:

Add 12.2.2.4 as follows:

12.2.2.4 Upon request by the Owner and prior to the expiration of one year from the date of Substantial Completion, the Architect will conduct and the Contractor shall attend an inspection and meeting with the Owner to review the Work. The Contractor shall correct any deficiencies in the Work, discovered during the inspection or at the meeting, within 7 days following the meeting.

ARTICLE 13 MISCELLANEOUS PROVISIONS:

13.5 TESTS AND INSPECTIONS:

At the end of paragraphs 13.5.1 and 13.5.3, add the following sentence:

“Contractor shall bear the cost of all failing tests.”

13.6 INTEREST:

13.6.1 Delete the wording “at such rate as the parties may agree upon in writing or, in the absence thereof;”

ARTICLE 14 TERMINATION OR SUSPENSION OF CONTRACT:

14.1 TERMINATION BY THE CONTRACTOR:

At the end of paragraph 14.1.3, change the words “overhead, profit and damages.” to “overhead and profit.”

Add the following Article 15:

ARTICLE 15 ADDITIONAL CONDITIONS:

15.1 POLICIES OF EMPLOYMENT:

- 15.1.1 The Contractor and all tiers of Subcontractors and suppliers shall not unlawfully discriminate against any employee or applicant for employment because of race, religion, color, sex, national origin, or age. The Contractor agrees to post in conspicuous places, available to employees and applicants for employment, and to place in solicitations for employees, notices setting forth policies of non-discrimination.
- 15.2 MINIMUM WAGE RATES:
- 15.2.1 Wage rates shall comply with 13-4-11 New Mexico Statutes Annotated, 1978 Compilation, as determined by the State Labor and Industrial Commission.
- 15.2.2 One copy of each certified weekly payroll shall be made available to the New Mexico State Labor and Industries Commissions, and the Owner, by the Contractor and each Subcontractor, no more than five working days after each payroll period upon request. Such payrolls shall depict the decision number for this project and the county in which the work is being performed. The Contractor shall post the scale of wages to be paid in a prominent and easily accessible place at the job site.
- 15.2.3 The Contractor shall pay all mechanics and laborers employed on the site of the project, unconditionally and not less often than once a week, and without subsequent unlawful deduction or rebate on any account, the full amounts accrued at time of payment, computed at wage rates not less than those stated in the advertised specifications.
- 15.2.4 In the event it is found by the State Labor Commission, that any laborer or mechanic employed by the Contractor or Subcontractor on the site of a project covered by the contract has been or is being paid, as a result of willful violation, a rate of wages less than the rate of wages required by the contract, Owner may, by written notice to the Contractor and his Subcontractor (if the violation involves a subcontractor) terminate their right to proceed with the work, or such part of the work as to which there has been a willful failure to pay the required wages and Owner may prosecute the work to completion by contract or otherwise, and the Contractor and Contractor's sureties shall be liable for any excess cost occasioned thereby. Any party receiving notice of termination of his Contract or subcontract under the provisions of this section may appeal the finding to the State Labor Commissioner as provided in the Public Works Minimum Wage Act.

END OF SECTION

J. F MADDOX FOUNDATION

220 West Broadway, Suite 200
Post Office Box 2588
Hobbs, New Mexico 88241-2588
Phone: (505) 393-6338
Fax: (505) 397-7266
www.jfmaddox.org

May 4, 2004

Steve McCleery, President
New Mexico Junior College
5317 North Lovington Highway
Hobbs, NM 88240

Dear Steve:

Attached is a draft Grant Contract for the Western Heritage Museum grant. I believe you will find that this Grant Contract to be highly consistent with the bulleted list of terms we previously discussed.

However, I thought it would be useful for you to personally review this document. Also, it would make sense to have the College's counsel review the Grant Contract before we prepare execution copies for your presentation to the College's Board of Trustees.

You will note that Exhibit II is not included in the attached material. I believe that the College should have access to either material that might directly serve this purpose or that might be useful in constructing an exhibit. Your guidance in this regard would be appreciated.

Please let me know if you have questions or concerns regarding this document.

Sincerely,



Robert J. Reid
Executive Director

Enclosure (1)
cc: file

GRANT CONTRACT

DRAFT

PARTIES

This Grant Contract, hereinafter referred to as the “Contract”, is entered into between **J. F Maddox Foundation**, 220 W. Broadway, Suite 200, Hobbs, New Mexico 88240, a New Mexico non-profit corporation, hereinafter referred to as the “Foundation”, and **New Mexico Junior College**, 5317 North Lovington Highway, Hobbs, New Mexico 88240, a New Mexico state community college, hereinafter referred to as “Grantee”, subject to the terms and conditions set forth below.

RECITALS

WHEREAS, Grantee has supported and operated the Lea County Cowboy Hall of Fame and Western Heritage Center, on its campus, since 1978 and desires to build a new facility to expand the Cowboy Hall of Fame and Western Heritage Center into a more comprehensive museum facility, hereinafter referred to as the “New Museum”, on its campus;

WHEREAS, Grantee has developed construction plans, received approximately \$3,250,000 from the State of New Mexico, and committed at least another \$500,000 of its own funds for the construction of the New Museum;

WHEREAS, Grantee’s Board of Trustees is committed to authorizing an appropriate level of funding for both the construction and ongoing annual operating expenses of the New Museum;

WHEREAS, Grantee's Board of Trustees and President requested a grant from the Foundation for \$1,350,000 to partially fund the completion of the construction of the New Museum;

WHEREAS, Grantee's Board of Trustees is committed to building the New Museum which shall contain no less than all of the design and features described and illustrated in Grantee's request to the Foundation (Exhibit I contains illustrations and descriptions of the design and features of the New Museum, which were included in Grantee's request), subject to the Foundation's commitment to provide a \$1,350,000 grant for this purpose;

WHEREAS, Grantee's Board of Trustees has committed to fund, from Grantee's own funds, any costs above those committed by all other sources as may be required to complete the construction of the New Museum;

WHEREAS, Grantee and the Foundation believe that the New Museum, as proposed by Grantee, represents considerable value for the residents of Lea County and surrounding communities;

WHEREAS, Grantee's Board of Trustees and President have formally approved the terms and conditions of this Contract; and

WHEREAS, the Foundation has approved a grant for \$1,350,000, subject to the terms and provisions of this Contract, to Grantee to assist in funding the construction of the New Museum.

It is hereby agreed by the Grantee and the Foundation as follows:

GRANT SPECIFIC PROVISIONS

1. The amount of this Grant shall be \$1,350,000. The funds from this Grant shall be made available to Grantee after all other sources of funding, including those funds provided by Grantee, have been expended. Grantee will provide to the Foundation, within 90 days of the execution of this Contract, an estimate of the times and amounts in which the funds from this Grant will be needed. Thereafter, and through the period of construction, Grantee will provide the Foundation, no less than quarterly, written reports, which update Grantee's estimated timing of funds needed from this Grant. All requests for funds from this Grant shall be made in writing and with at least 30 days advance notice.
2. Grantee has informed the Foundation that it intends to recruit and employ a professional museum curator as soon as possible, contingent upon the execution of this Contract. Grantee acknowledges that the success of the New Museum is, to a large extent, dependent upon the timely employment, by Grantee, of a qualified, experienced professional curator. Grantee, therefore, agrees to secure and utilize appropriate expertise to initiate a search for an appropriately qualified

curator upon execution of this Contract. Once a qualified candidate is identified, Grantee agrees that the museum curator position will be occupied as soon as possible, preferably before the start of construction of the New Museum. Grantee agrees to, at its own expense, continuously maintain a professional curator to manage and promote the New Museum and its programs.

3. Grantee must begin construction of the New Museum no later than December 31, 2004. Furthermore, facility and exhibit construction must be complete and ready for occupancy no later than January 31, 2006. The Foundation's commitment herein becomes null and void if the New Museum (facility and all planned exhibits) is not fully completed and operational by January 31, 2006. Under such circumstance, all obligations of the Foundation hereunder will terminate. Should the Foundation's obligations hereunder terminate, Grantee shall not be required to refund, to the Foundation, any funds from this Grant, which have already been provided to Grantee by the Foundation.

4. Grantee agrees to build the New Museum and completely outfit the New Museum with exhibits, equipment, furnishings, and landscaped grounds in a manner, which is substantially consistent with the description contained in Exhibit II.

******NMJC to provide materials to serve as Exhibit II******

5. Grantee agrees to assume full financial responsibility for any capital expenditures incurred with this project (i.e., construction, exhibits, furniture, equipment, signage), which exceed the funds raised from other sources, including this Grant.

6. Upon the completion of construction of the New Museum, Grantee agrees to provide an ongoing financial subsidy for the effective operation of the New Museum in an amount of not less than \$250,000 annually, which shall be in excess of any revenues generated by the New Museum, hereinafter referred to as the "Base Annual Subsidy." The Base Annual Subsidy shall be applied to direct operating expenses of the New Museum and not be offset by allocations of organizational overhead expense. Each year, immediately following the approval of Grantee's operating budget, Grantee shall provide to the Foundation, written evidence of recommitment by its Board of Trustees to the Base Annual Subsidy. Such evidence of recommitment shall be provided in the form of a resolution adopted by Grantee's Board of Trustees.

7. In addition to the Base Annual Subsidy, Grantee commits to maintain the New Museum facilities to a standard at least equal to the maintenance standard applicable to Grantee's other facilities. This is intended to include, but not be limited to, preventative maintenance, repairs, replacement, and/or upgrading of facilities, exhibits, equipment, furnishings, and grounds.

8. Grantee acknowledges that the Foundation will not consider requests for ongoing operational and/or subsequent capital support for the New Museum.

9. Grantee agrees to implement the recommendations of its museum consultant, Southwest Museum Services, in planning the operations and promotion of the New Museum. This shall include, but not be limited to, the establishment of an advisory committee, with a majority of members who are not employees of Grantee, to provide oversight and input of the operations and promotion of the New Museum.

10. During the period of construction of the New Museum, Grantee agrees to provide the Foundation with written reports, on a monthly basis, with respect to the progress of construction, the status of staffing the facility including the activities of the curator, Grantee's compliance with the terms of this Contract, and any other material facts and/or developments regarding the New Museum. Thereafter, and for a period of not less than 10 years following the completion of the New Museum, for each academic year, Grantee agrees to provide the Foundation with a comprehensive annual report including, but not limited to, the following:
 - The number of museum visitors (with sufficient demographic analysis to properly evaluate how the New Museum is being utilized).
 - Plans to achieve increased utilization of the New Museum.

- The number of theatre showings with average show attendance per category of showing.
- Status of staffing of the New Museum including the continuous employment of a qualified curator.
- Listing of significant accomplishments/challenges.
- Report of expenditures.
- The latest operating budget.
- Plans for improving and/or expanding the New Museum.
- Updated list of the members of the advisory committee of the New Museum.
- Other information as may be requested by the Foundation in order to evaluate the effectiveness of its investment in the New Museum.

Annual comprehensive reports shall be due to the Foundation by no later than September 30 of each year and shall cover activities through the immediate past academic year, as well as address subsequent events of consequence. The first annual report shall be submitted to the Foundation by no later than September 30, 2006.

GENERAL PROVISIONS

1. Grantee agrees to notify the Foundation immediately, in writing, if (a) Grantee's federal tax-exempt status is revoked or altered; (b) Grantee has reasonable grounds to believe that its tax-exempt status may be revoked or altered; or, (c) Grantee has reason to believe that these grant monies cannot be or continue to be

expended for the specified purpose. In the event that Grantee loses its tax-exempt status before all funds under this grant are dispensed, this Contract will be considered null and void and all obligations of the Foundation hereunder will terminate.

2. Grantee certifies that the instant grant will not jeopardize Grantee's status as not a private foundation under Section 509 of the Internal Revenue Code.
3. Grantee will cooperate with the Foundation in supplying additional information or in complying with any procedures that might be required by any governmental agency in order for the Foundation to establish the fact that it has observed all requirements of the law with respect to this grant. Grantee specifically agrees that no part of the funds received from this grant will be used to carry on propaganda, influence legislation, influence the outcome of any specific public election, or carry on, directly or indirectly, any voter registration drive.
4. Grantee shall not assign this Contract or any payment due or to become due under this Contract without the prior, express, and written consent of the Foundation.
5. The obligations of the Foundation under this Contract shall terminate, at the option of the Foundation, if Grantee: (a) admits in writing that it is unable to pay its debts as they become due; (b) applies for or agrees to the appointment of a receiver or trustee in liquidation of itself or any of its properties; (c) makes a

general assignment for the benefit of creditors; (d) files a voluntary petition in bankruptcy or a petition seeking reorganization or an arrangement with creditors under any bankruptcy law; (e) is a party against whom a petition under any bankruptcy law is filed and admits the material allegations in such petition filed against it; or (f) is adjudicated as bankrupt under any bankruptcy law.

6. This Contract may only be amended by mutual written consent of the Foundation and Grantee.

7. If any clause or provision of the Contract is illegal, invalid, or unenforceable under present or future laws, the remainder of this Contract shall not be affected thereby, and in lieu of each clause or provision of this Contract which is illegal, invalid, or unenforceable, there shall be added as a part of this Contract a clause or provision as nearly identical to the said clause or provision as may be legal, valid, or enforceable.

8. This Contract embodies the entire agreement of the parties, and no statements, promises, or inducements made by either party or agent of either party that are not contained in this written Contract shall be valid or binding. There are no promises, terms, conditions, or obligations other than those contained herein; and this Contract shall supersede all previous communications, representations, or agreements, either verbal or written, between the parties as to the subject matter of this Contract.

9. By making this Grant, the Foundation assumes no responsibility for any injury, damages, or liability arising out of the Grant or any contract, product, service, or operations for which the Grant is utilized or intended. By accepting this Grant, the Grantee agrees to indemnify and hold harmless the Foundation, its board of directors, officers, employees, and agents from any liability or claims arising out of, or related to, the Grant.

Executed on the date(s) set forth below:

J. F MADDOX FOUNDATION

NEW MEXICO JUNIOR COLLEGE

By _____
Robert J. Reid
Executive Director

By _____
Lawrence Hanna
Chairman, Board of Trustees

Dated _____

Dated _____

By _____
Steve McCleery, Ed.D.
President

Dated _____

EXHIBIT 1

A New Plan for
The Lea County Cowboy Hall of Fame
& Western Heritage Center



prepared by



Dekker Perich Sabatini

architecture
interiors
planning
engineering

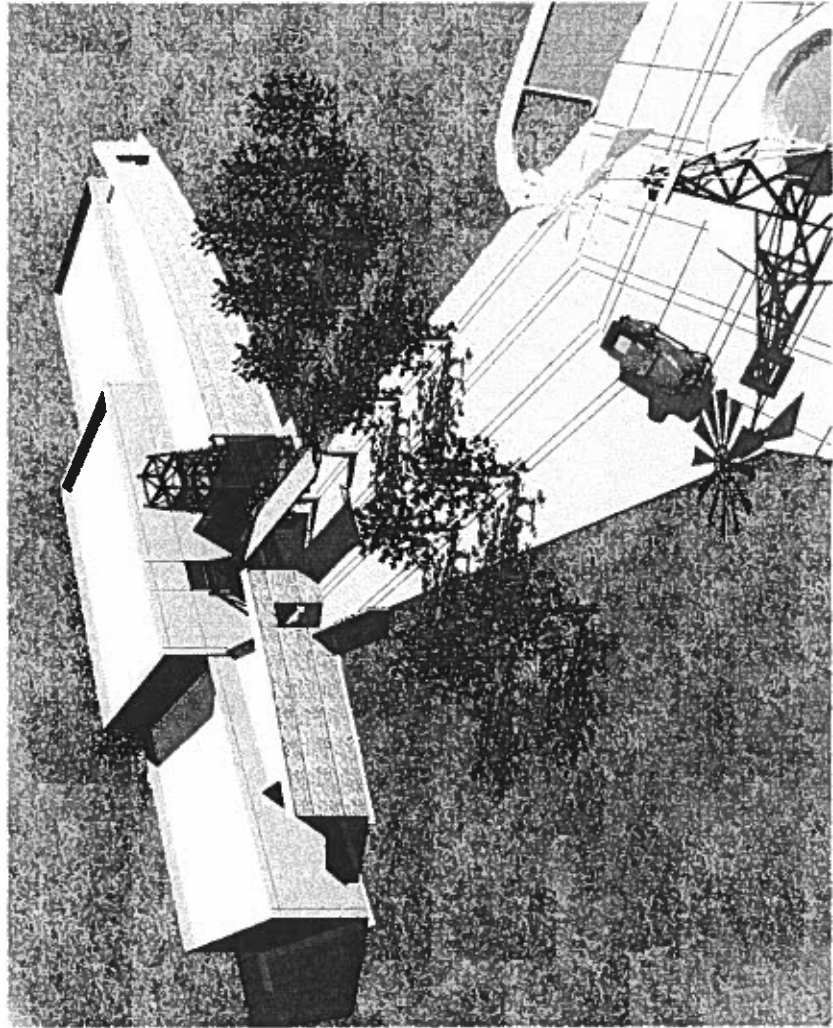

A New Plan
for
The Lea County Cowboy Hall of Fame
& Western Heritage Center

At the request of New Mexico Junior College, Dekker/Perich/Sabatini of Albuquerque and Southwest Museum Services of Houston have reconfigured and rebudgeted the new building and exhibits for the Lea County Hall of Fame and Western Heritage Center. This plan provides for a smaller structure than the originally-designed museum building, but it also retains the scale and frontage of the original plan. In addition, the new plan provides for an exciting focal exhibit for the lobby, all new exhibits throughout the museum, and a 141-seat wide-screen theater.

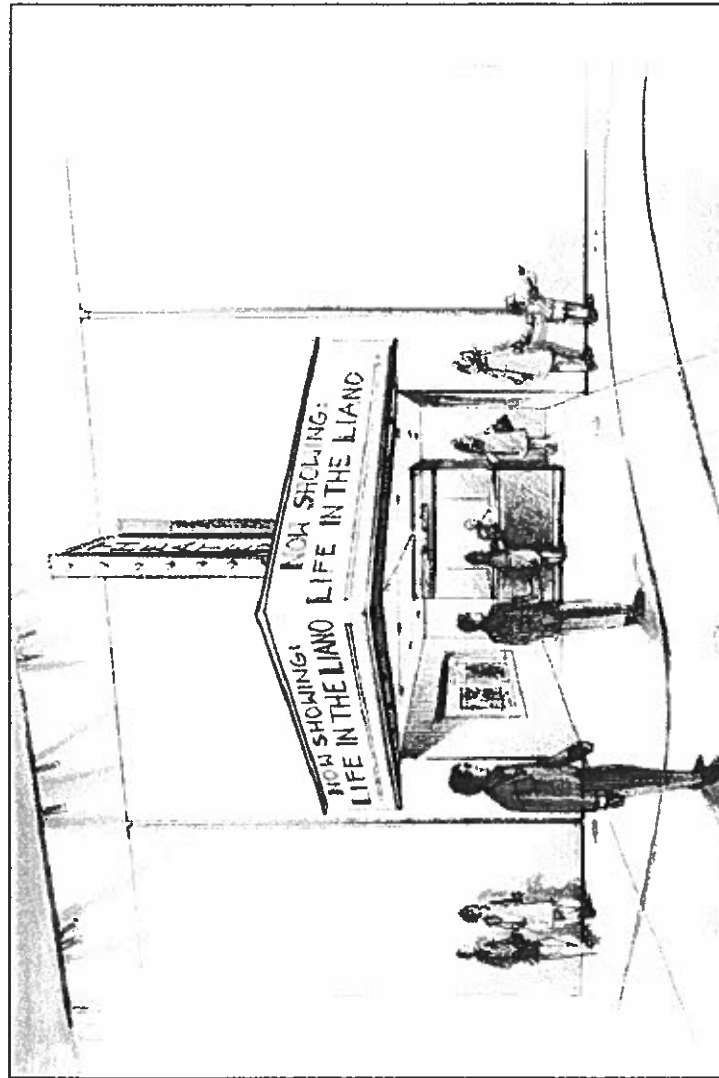

Revised Budget for the Reconfigured Building Lea County Cowboy Hall of Fame & Western Heritage Center

Statement of Probable Costs

A. Main Building: (cost includes 5% contingency)	\$3,383,280
· Lobby finished	
· Office finished	
· Temporary gallery finished	
· Theater risers built, ready to receive finish	
· Cowboy Hall of Fame moved to lobby/hallway	(35,208)
B. Western Heritage Center: (cost includes 5% contingency)	651,681
· Now located in area previously called the Cowboy Hall of Fame	
· Now one large room ready to receive finish/exhibits	
C. Landscaping and courtyard: (cost includes 5% contingency)	200,000
· Courtyard paving and planting and stone veneer	
· Trees, plantings, etc...	
D. A & E fees:	82,956
E. Building chillers/boiler in lieu of central plant connection:	(157,607)
Project Subtotal	4,125,102
F. Exhibit Budget:	979,150
Includes Theater projector(s) and screen and special lighting	
· Cowboy Hall of Fame built-in cases	
· Family Concept: Western Heritage Center integrated with Children's Museum	
· Finish out of WHC, CHoF	
Total Project Cost	5,104,252
Current Funding	3,144,252.53
Alternative Funding Source	2,000,000.00
Finish out of theater (carpet, 141 seats, acoustical treatment)	(40,000.00)
Projected Total Project Budget	\$5,104,252.53

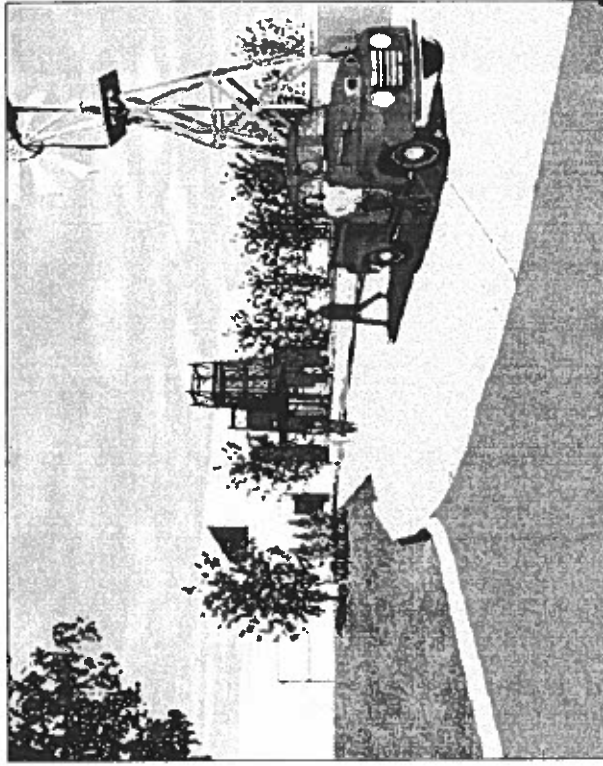

Budget Detail

Main Building

The Main Building includes the finished Lobby, Office area, Theater, Storage, and Temporary Gallery, ready to receive exhibits. The building construction budget for this portion of the building is \$3,383,280 (Cost includes 5% contingency).

The reconfigured Main Building provides the basic space for the Lobby, the Cowboy Hall of Fame, Museum offices, Gift shop area, Receiving and Storage area, a Temporary Exhibits Gallery, and a wide-screen video Theater.

The Lobby and Corridor, comprising more than 7,200 square feet, includes a centerpiece featuring a chuckwagon diorama and animated life-sized computer-driven talking cowboy. A centrally located information/ticket counter provides visitors with appropriate information for touring the Museum's exhibits. The Museum's administrative offices are also close at hand and a small gift shop area will allow visitors to purchase items related to the Museum's educational themes.

The configuration of the Lobby allows the Museum to be opened and maintained with a minimal staff.

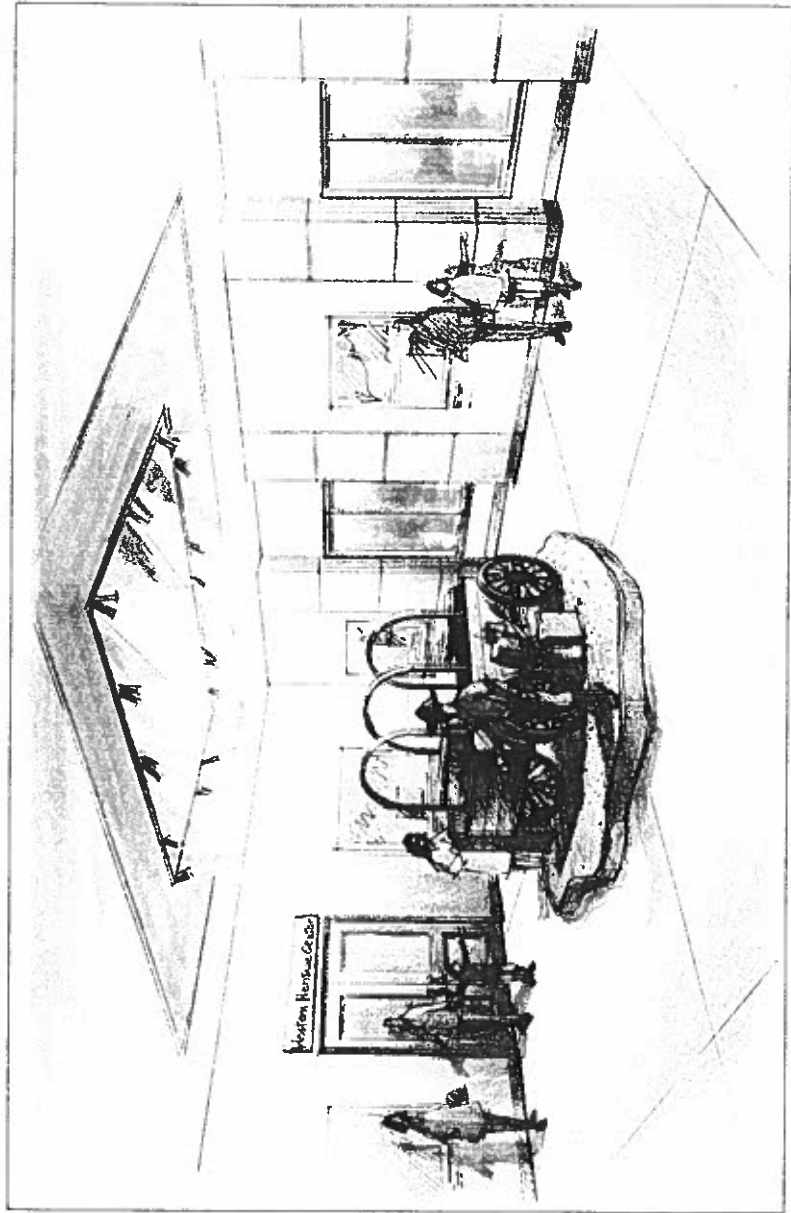

The Lobby will also serve as the home for the Lea County Cowboy Hall of Fame.

Exhibit cases for each honoree will be on each side of the wide corridor leading to the Theater. Attractive graphic panels and personal artifacts will tell the remarkable story of the inductees. Cases along the long curved wall will be built into the wall.

Arranged by year of induction, the Hall of Fame serves to tell the unique story of Southeastern New Mexico through the lives of its finest citizens. Currently 68 have been inducted into the Hall of Fame. The Gallery will be designed to accommodate 90 inductees.

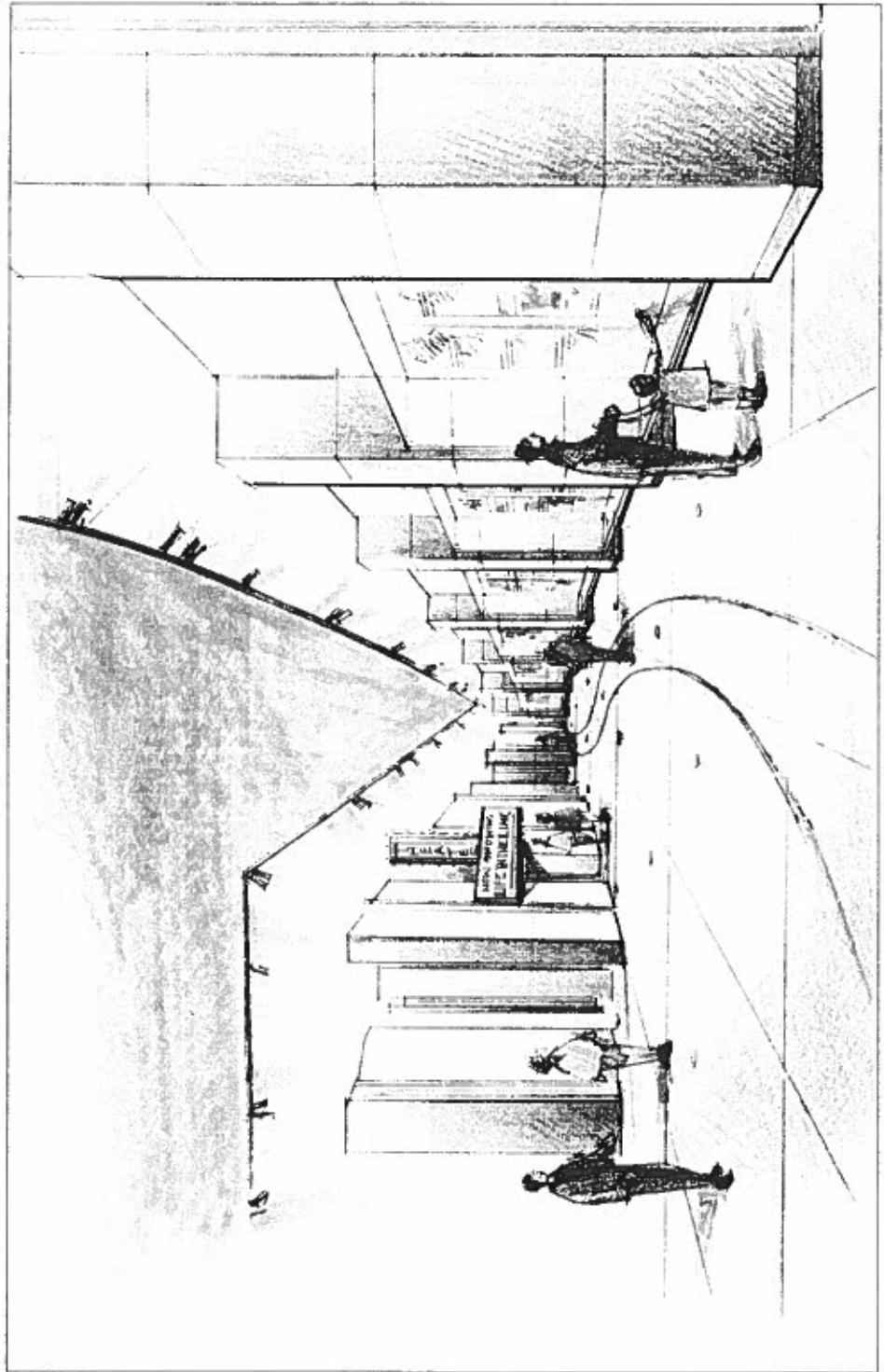

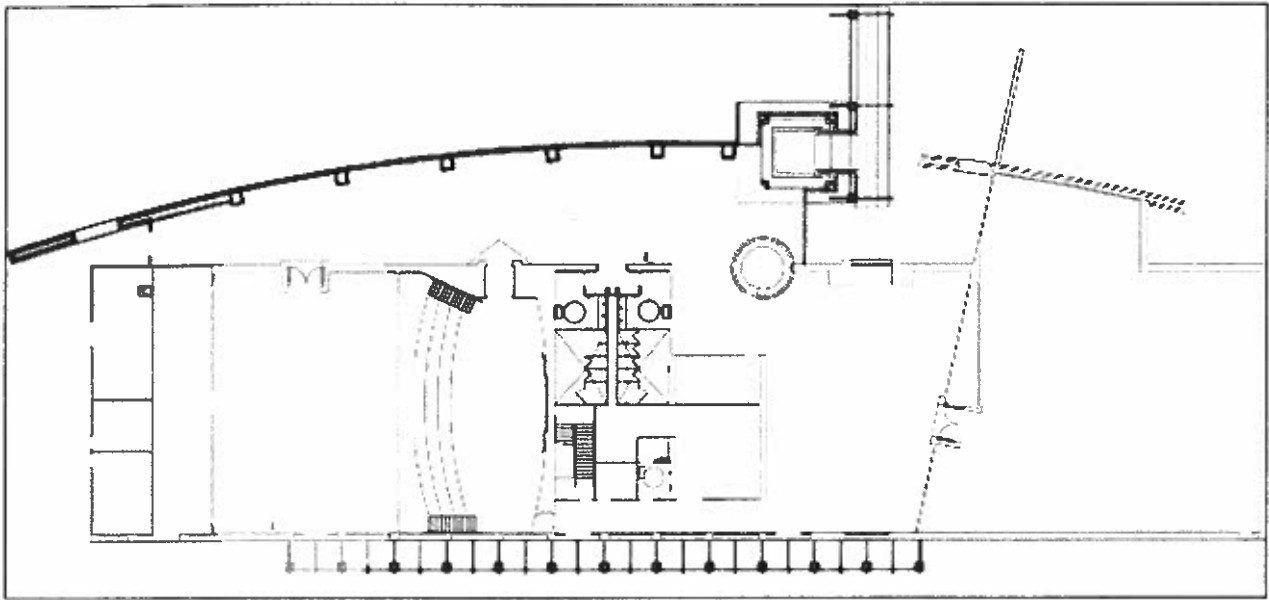

The Temporary Exhibits Gallery allows for traveling exhibits, receptions, and other multiple use functions. The adjacent Storage Area provides space for loading and unloading exhibits.

This large gallery of 2,687 square feet will become the Museum's multipurpose room, suitable for use for rotating and traveling exhibits, short-term museum exhibits, meetings, and receptions. Its location is ideal in that visitors must pass the Theater entrance and through the permanent exhibits of the Cowboy Hall of Fame to enter the Temporary Exhibits Gallery. This gallery allows the Museum to offer a flexible program that will bring visitors back to the Museum several times a year.

Adjacent to the Temporary Exhibits Gallery is a Storage Area of 894 square feet. This area serves as a receiving/shipping/setup area for traveling exhibits as well as Museum storage. The room is accessed from the exterior by a large roll-up door; its adjacency next to the Temporary Exhibits Gallery makes exhibit setup and removal quite easy for the Museum staff.

The Theater will offer a wide selection of educational and historic films in wide-screen high-resolution video.

The Theater will provide seating for 141 with chairs that serve both as theater seats and classroom desks. Featuring a 24-ft. wide screen, the Theater will be equipped with a video system that will project wide-screen presentations as well as conventional video. Computer links will also allow it to function as a Smart Classroom.

The Theater will also function as the Museum's Orientation Center with the development of an orientation film. It will also serve the community as a mid-sized meeting room. Its convenient adjacency to the Temporary Exhibits Gallery allows the two areas to be used as a center for small group meetings.

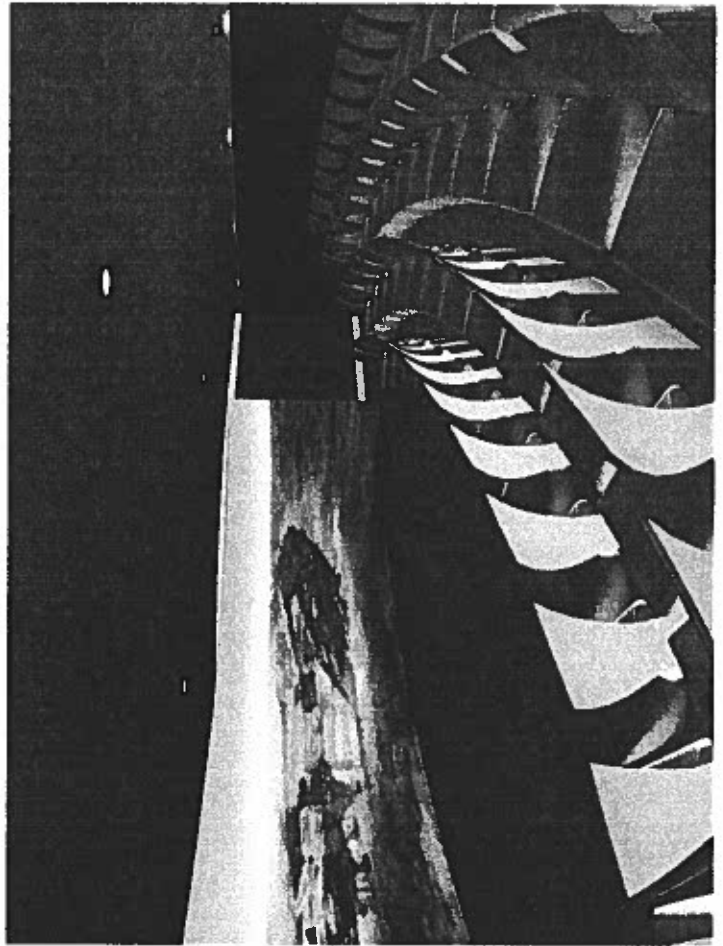
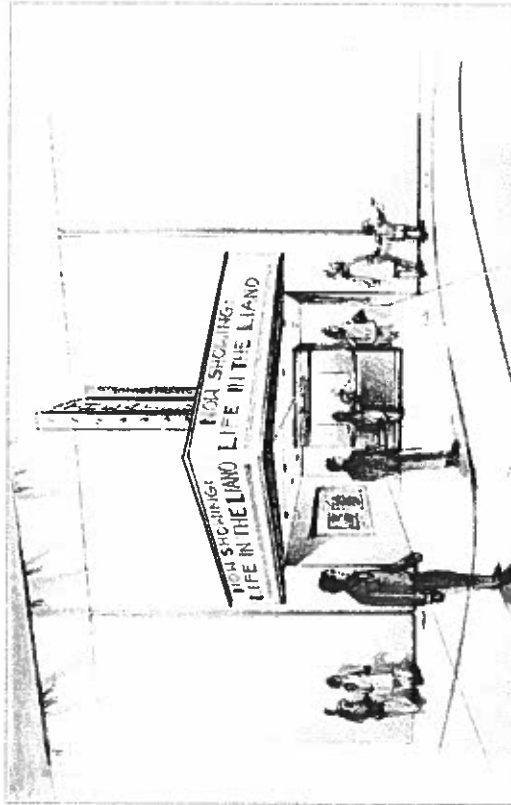

Western Heritage Center & Children's Museum Wing

The Western Heritage Center & Children's Museum Wing includes 5,206 square feet ready to receive new exhibits. Cost for building construction is \$651,681 (cost includes 5% contingency).

This rectangular room will allow incorporation of the major elements of the exhibits that were designed for the previously planned Western Heritage Center and Children's Museum. By combining these elements into the same area, the Western Heritage Center becomes a true family museum. Exhibits will be offered on both an adult and child level. This new family center will be a place where children can explore immersive interactives, and at the same time adults can learn from the informational and graphic content as well as the various dioramas. The area also will allow the museum to stage specialized programming at both the children and adult level. This major change in the concept for the museum not only allows for economy of space but also provides a richer environment for learning.

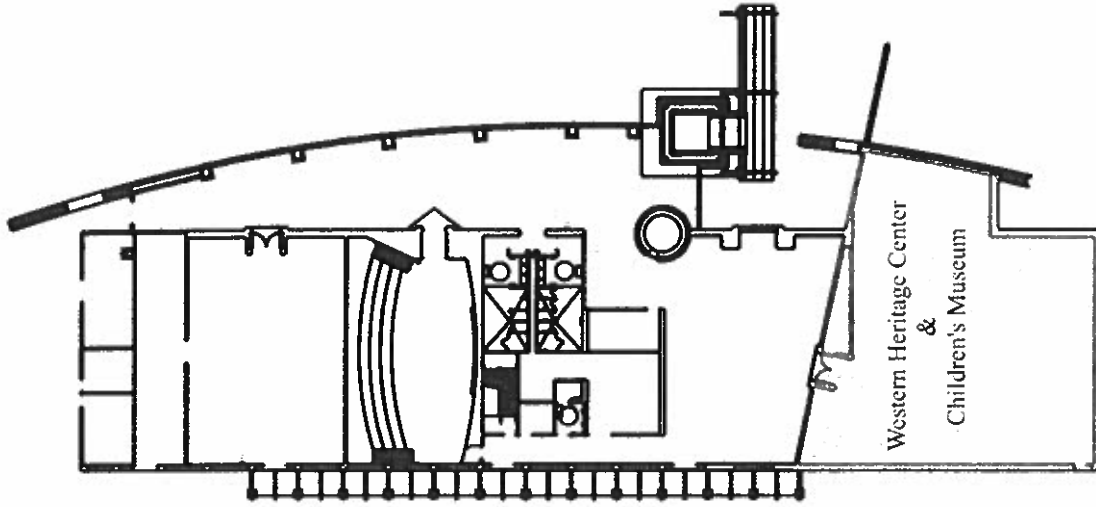

The combined Western Heritage Center & Children's Museum will interpret the rich and exciting history of Southeastern New Mexico through a series of interactive exhibits.

Visitors to the Western Heritage Center will experience a walk-through of the region's rich and diverse past. From the earliest living things to a fascinating diorama of the region's wildlife, visitors will begin to sense the unique relationship of life to the land. Children can enter a prairie dog "tunnel" and pop up in the middle of grazing deer.

Other exhibits herald mankind's struggle with the land, primarily through a series of interactive structures, including an Ochoa house, a tipi, a primitive dugout, an early ranch home, a school and general store. Additional exhibits deal with the exploration and development of the region as a ranching, agricultural and oil center.

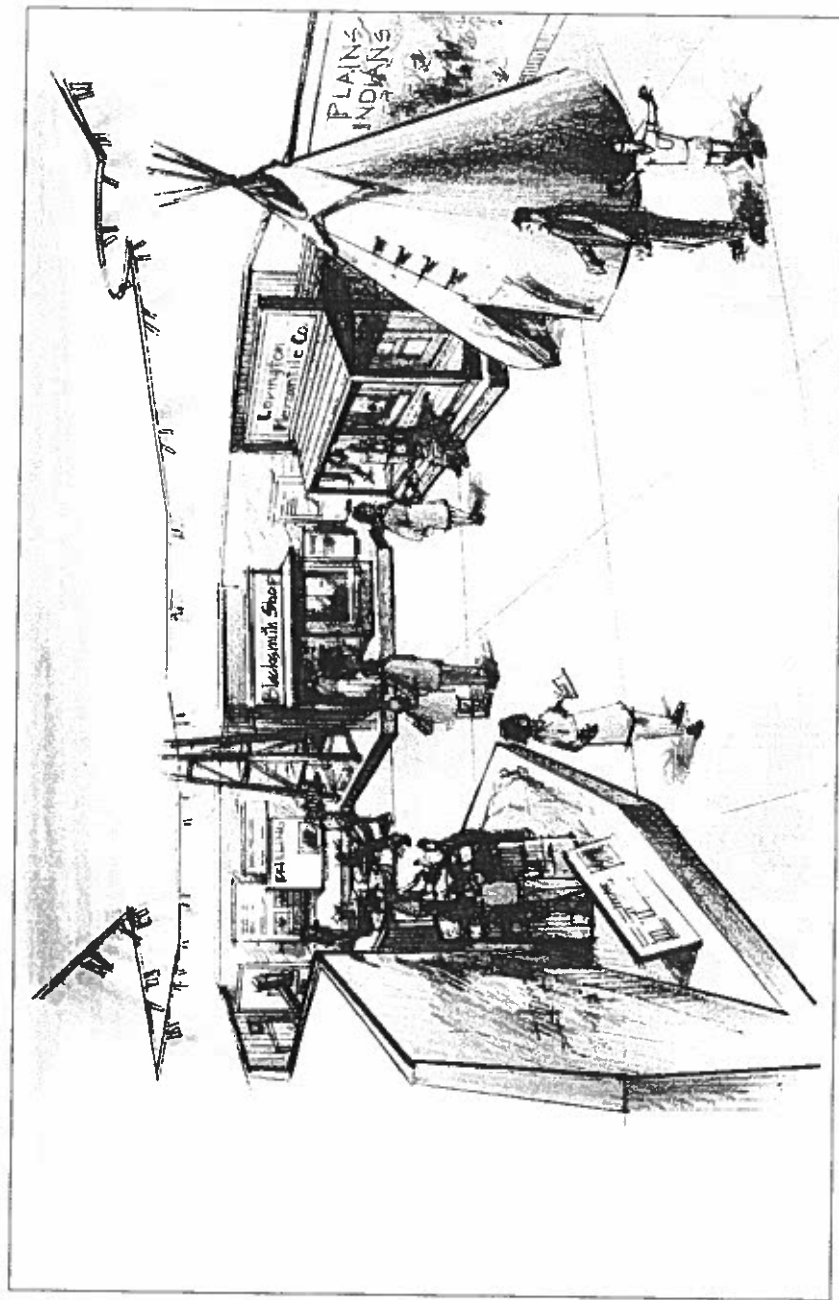

Courtyard and Landscaping

The attractive Courtyard will allow the Museum to stage outdoor functions in an attractive setting. It also provides a place for exhibiting artifacts that are too large to be inside the Museum.

Because of its close proximity to the interior exhibits, the Courtyard can serve as a gallery unto itself as well as a major activity area. The portico will provide shelter for outdoor events and the Courtyard will host a variety of outdoor activities. The Museum's large artifacts, such as its firetruck, drilling rigs and other items can be exhibited in this area. Appropriate landscaping will provide opportunity for interpretation of the region's unique plant life.

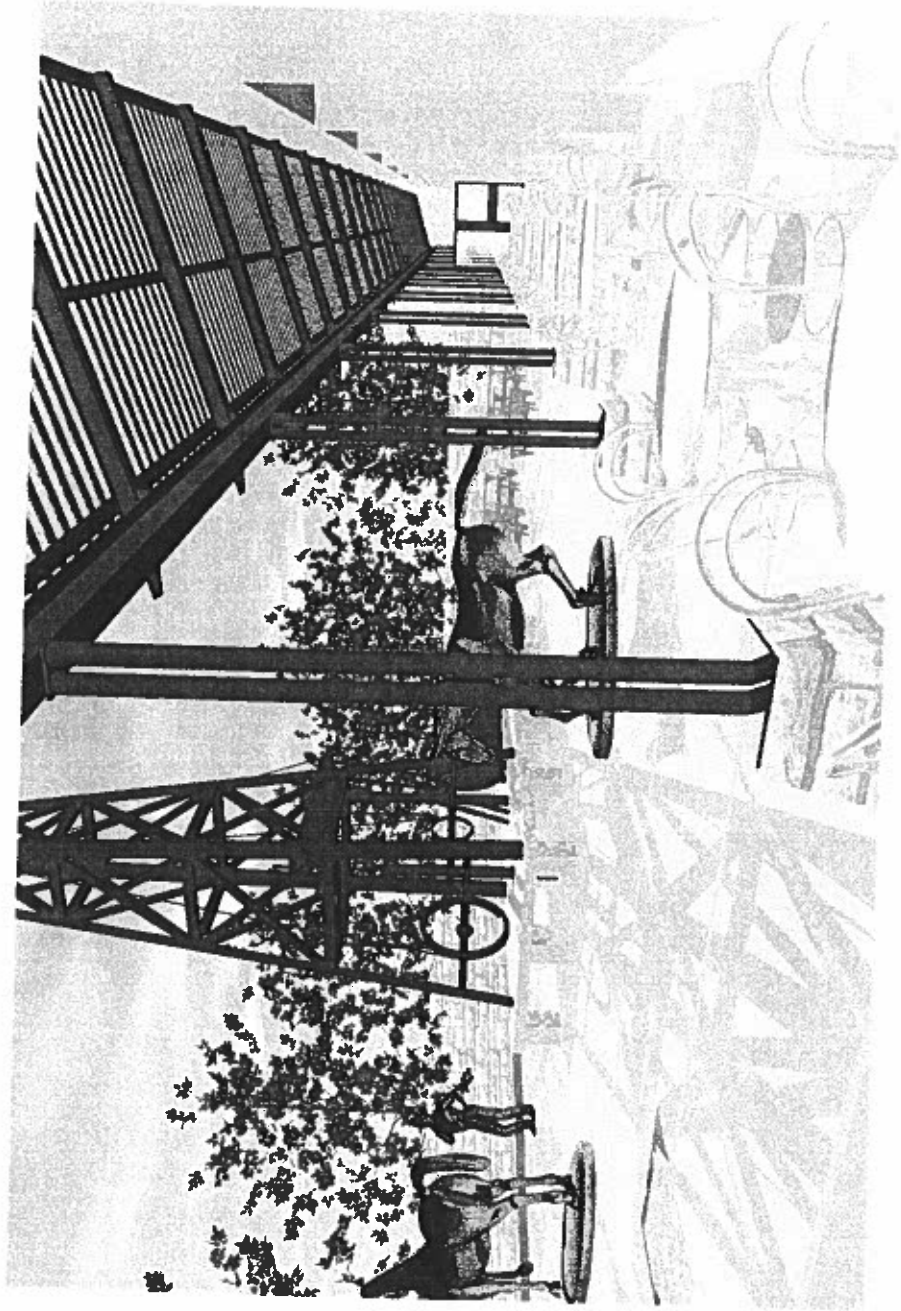

Exhibits Budget

The Exhibit Budget includes the re-design, construction and installation of the following:

Wide Screen Video projection and digital playback, sound system, room lighting, 12 ft x 24 ft screen (does not include seating, risers, or floor finishes)

\$90,000

Lobby Exhibit: to include animated cowboy and chuckwagon diorama

\$55,000

Cowboy Hall of Fame exhibits to be reconfigured for lobby and front hallway, including fabrication, lighting, shipping, installation

\$285,000

Western Heritage/Children's Museum exhibits to be reconfigured to fit into south wing, to include fabrication, lighting, shipping, and installation

\$549,150

Total Exhibits Budget

\$979,150



Project Summary and Proposed Funding

Total Building Cost	\$4,125,102
Exhibit Cost	<u>\$ 979,150</u>
Total Project Cost	\$5,104,252
Current Funding	\$3,144,252
Alternative Funding Source	\$2,000,000
Finish out of theater (carpet, 141 seats, acoustical treatment provided by NMJC	<u>(\$ 40,000)</u>
Projected Total Project Funding	\$5,104,252

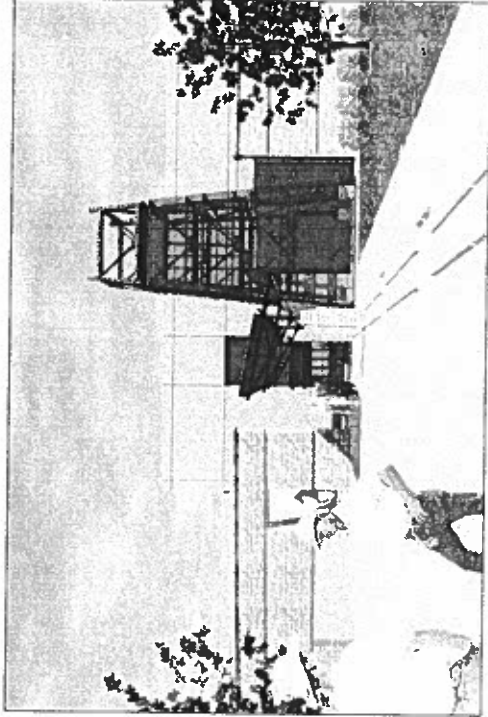

Western Heritage Center
Estimated Yearly Operational Cost
260,000 – 280,000

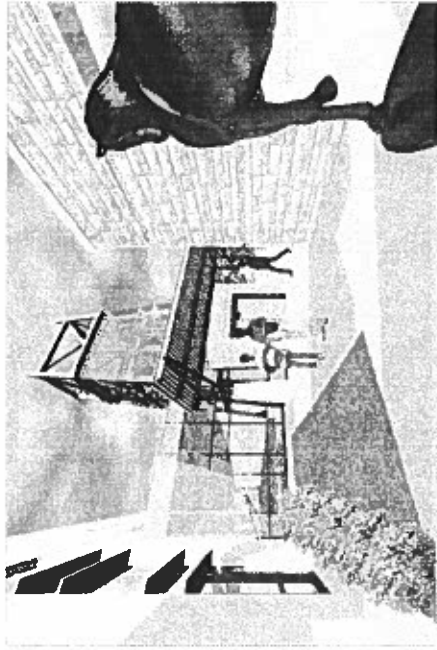

Salaries - Professional	\$83,582
Benefits - Professional	20,895
Salaries - Support	20,568
Benefits - Support	5,142
Copier expense	1,500
Travel	2,500
Telephone - long distance	300
Postage	2,000
Supplies & expense	3,000
Staked Plain Roundup	1,000
26,985 square feet	150,000

§ Insurance	
§ Heating	
§ Cooling	
§ Electrical/lighting	
§ Custodial	
§ Custodial supplies	
§ Grounds	
§ Grounds/supply	
§ Maintenance	
§ Maintenance supply	
	\$290,487

Instructional space - formula???	
§ Theatre/classroom 2639 @ 3.68	9,711
§ Classroom/exhibit gallery 3012 @ 3.68	11,084

Total Estimated Operational \$269,692

EXHIBIT II – NMJC TO PROVIDE

NEW MEXICO JUNIOR COLLEGE

REQUEST FOR PROPOSALS #79

Purchase & Installation of Copiers for NMJC

BOARD DOCUMENTS

**Date: April 27, 2004
Prepared by: Frank D. Collins
Coordinator of Purchasing**

NEW MEXICO JUNIOR COLLEGE

BOARD DOCUMENTS

General Information

1. On February 4, 2004, a legal notice was sent to the following newspapers requesting sealed proposals to provide copiers to NMJC:
 - 1) The Hobbs Daily News Sun
 - 2) The Lovington Leader
 - 3) The Roswell Daily Record
2. The RFP was also posted on the NMJC website.
3. Two (2) vendors submitted proposals in compliance with the opening date and time. One vendor, Fingerprint Graphics did not respond to the RFP.
4. No bidders were present at the opening.
5. The Business Office and College Communications personnel have evaluated the proposals received and their recommendation is shown on Page 3.

NEW MEXICO JUNIOR COLLEGE

Evaluation and Recommendations

Board Documents

The following vendors responded to the Request for Proposals #79:

Copies, Inc., Hobbs NM

Benchmark Business Solutions, Lubbock TX

The proposals were evaluated by a selection committee which comprised the following individuals: Sam Oswald, Dean of Continuing Education/Community Services, Dana Martin, Document Centre Supervisor, Tim Perry, Director of College Communications, and Frank Collins, Coordinator of Purchasing.

The Administration recommends acceptance of the pricing structure submitted by Benchmark Business Solutions for \$217,982.00. The evaluation chart and cost summary are detailed on Pages 4 through 6.

Source of Funding: 2003/2004 FY Equipment Renewal & Replacement
Account Number: 7-2741-02-200
Total: \$217,982.00

New Mexico Junior College

Board Documents

Evaluation Summary

Proposal Evaluation Criteria

Section	Copies Inc.	Benchmark Business Solutions	Total Points Assigned
^Price	24.43	25	25
Reliability / stability of firm personnel	25	25	25
References	25	25	25
Ability to service NMJC	25	25	25
Total	99.43	100	100

^ lowest cost proposal divided by the other cost proposal = X; then take X times the 25 points (total assigned for that section). Calculations are as follows:

^Benchmark: $\$217,982.00 \div \$217,982.00 = 1 \times 25 \text{ points} = \underline{25 \text{ points}}$

^Copies Inc.: $\$217,982.00 \div \underline{\$22,066.00} = .9772 \times 25 \text{ points} = \underline{24.43 \text{ points}}$

Benchmark total points awarded for references: 65 (All 5 references responded)

Benchmark had one reference with a non-networked system.

Copies Inc. total points awarded for references: 57 (All 5 references responded)

Copies Inc. only had one reference with a networked system.

Vendors

In our RFP we requested 16 copier/printers for the entire campus. We received bids from Copies, Inc. and Benchmark.

Equitrac

Both companies offered Equitrac for our billing purposes. Copies, Inc.'s price for the Equitrac system is higher because we also have to purchase Secure Print (\$889.00 per machine) for each copier/printer to enable the machines to hold the job until the user can go to the machine and release it. This way no copies are laying around for others to pick up by mistake. We also have to purchase hardware (\$996.00 per machine) to make the Sharp copiers compatible with the Equitrac system. We will have to purchase a maintenance agreement on all extra hardware. The cost for the maintenance for the Equitrac System and all needed hardware is \$9,036.00 per year after the first year. The Xerox copier/printers from Benchmark come equipped with these 2 features at no extra cost to us. The maintenance is \$2,400.00 per year for the Equitrac System.

Installation & Training

Copies, Inc.'s local staff will provide installation of the networked copier/printers and train us for no fee. Benchmark will send in a crew to do the installation and training at a cost of \$12,078.00.

References

Copies, Inc. and Benchmark both received good scores from the references. Of the five references for Copies, Inc. only one company (Maddox Foundation) had a networked copier. For Benchmark, all companies were networked except Carlsbad Medical.

Cost

The following table shows the cost of the campus copiers, 5 years maintenance for the copiers, cost of the Equitrac System, and 5 years maintenance on the Equitrac system and all additional hardware.

Company	Copies, Inc. (Sharp)	Benchmark (Xerox)
Cost of 16 copiers	\$115,817.00	\$131,044.00
Copier Maintenance for 5 years	\$29,125.00	\$35,770.00
Equitrac System	\$41,980.00	\$27,090.00
Equitrac Maintenance for 5 years	\$36,144.00	\$12,000.00
Installation & Training	0	\$12,078.00
Total Cost for 5 Years	\$223,066.00	\$217,982.00

RFP #79 Evaluation Summary		Copies Inc.		Benchmark Business Solutions		Maintenance		Total cost with 5 years maintenance	
Networked Specifications	Price per Unit	Total	Price Per Unit	Total	Maintenance (Copies Inc.) per year	Maintenance (Benchmark) per year	Copies Inc. Sharp	Benchmark Xerox	
	Cost	Cost	Cost	Cost					
Networked Copiers (9) Stapler/Finisher	\$ 7,395.00	\$ 66,555.00	\$ 8,229.00	\$ 74,061.00	\$ 3,255.00	\$ 4,024.00			
Networked Copiers (5) No Stapler or Finisher	\$ 6,520.00	\$ 32,600.00	\$ 7,174.00	\$ 35,870.00	\$ 1,490.00	\$ 2,236.00			
Networked Copier / Printer/Scanner Network (1) Stapler/Finisher	\$ 7,995.00	\$ 7,995.00	\$ 11,579.00	\$ 11,579.00	\$ 350.00	\$ 447.00			
Networked Coin Operated Copier (1) No Stapler/Finisher	\$ 8,667.00	\$ 8,667.00	\$ 9,534.00	\$ 9,534.00	\$ 730.00	\$ 447.00			
Fax machines (10) Non network laser Do not get fax units at this time									
Total for copiers		\$ 115,817.00		\$ 131,044.00	\$ 5,825.00	\$ 7,154.00		\$131,044 (Purchase Price) + \$35,770.00 (5 yr. Maintenance) = \$166,814.00	
Print Software (Print Audit 4) 3 yrs maint. Change to Equitrac									
Accounting software - Equitrac (1)	\$ 3,919.00	\$ 3,919.00	\$ 21,890.00	\$ 21,890.00					
Hardware needed for 18 copiers	\$ 996.00	\$ 17,928.00	N/A	N/A					
Dservices (one time charge) (installation & training)	\$ 3,000.00	\$ 3,000.00	\$ 5,200.00	\$ 5,200.00					
DDT (Sharp) (accounting option) (1)	\$ 1,131.00	\$ 1,131.00	N/A	N/A					
Secure document release option (18)	\$ 889.00	\$ 16,002.00	N/A	N/A					
Annual maintenance software for Equitrac (1)					\$ 882.00	\$ 2,400.00			
Annual maintenance of hardware					\$ 8,154.00				
Total for Equitrac		\$ 41,980.00		\$ 27,090.00	\$ 9,036.00	\$ 2,400.00		\$41,980.00 (Equitrac purchase price) + \$36,144.00 (5 yr. Maintenance) = \$78,124.00	
Analyst installation one time charge (Xerox only) 9 copiers	N/A	N/A	\$ 730.00	\$ 6,570.00					
Analyst installation one time charge (Xerox only) 5 copiers	N/A	N/A	\$ 730.00	\$ 3,650.00					
Analyst installation one time charge (Xerox only) 1 netwk	N/A	N/A	\$ 1,638.00	\$ 1,638.00					
Analyst installation one time charge (Xerox only) 1 coin op	N/A	N/A	\$ 220.00	\$ 220.00					
Total Installation Fee for copiers		\$		\$ 12,078.00				\$	
Total								Total \$144,942 (copiers) + \$78,124.00 (Equitrac) = \$223,066.00 total for 5 years	

Total cost of purchase over 5 years if we use Copies Inc. = \$223,066.00
Total cost of purchase over 5 years if we use Benchmark = \$217,982.00

NEW MEXICO JUNIOR COLLEGE

REQUEST FOR PROPOSALS #84

Audit Services

BOARD DOCUMENTS

Date: May 14, 2004
Prepared by: Frank D. Collins
Coordinator of Purchasing

NEW MEXICO JUNIOR COLLEGE

BOARD DOCUMENTS

General Information

1. On April 30, 2004, a legal notice was sent to the following newspapers requesting sealed proposals for audit services:
 - 1) Hobbs Daily News Sun
 - 2) Albuquerque Journal
 - 3) Las Cruces News Sun
2. The RFP was also posted on the NMJC website.
3. Three proposals were submitted in compliance with the opening date and time.
4. The proposers were not present at the opening.
5. The Business Office Evaluation Committee has evaluated the proposals received and their recommendation is shown on Page 3.

NEW MEXICO JUNIOR COLLEGE

Evaluation and Recommendations

Board Documents

The audit firms responding to the RFP were:

Patillo, Brown & Hill, L.L.P., Albuquerque NM
Accounting & Consulting Group, LLP, Clovis NM
Johnson, Miller & Co., Hobbs NM

The proposals were evaluated by an evaluation committee, comprised of Dan Hardin, Vice President of Finance, Jennifer Jordon, Executive Director of NMJC Foundation, and Frank Collins, Coordinator of Purchasing. See Pages 7 through 9 for the Evaluation Criteria Summary.

The Administration recommends acceptance of the professional services of Johnson, Miller & Co. for audit services for the 2003/2004 fiscal year at an annual cost of \$36,630. The college may opt to renew the contract annually for up to two additional years. The total multi-year cost is \$114,720.

Source of Funding: FY 2004/2005 External Audit Fees
Account Number: 11000_102571257131
Amount: \$36,630.00

Points Summary:

Patillo, Brown & Hill, L.L.P. – 69

Accounting & Consulting Group, LLP – 85

Johnson, Miller & Co. - 88

NEW MEXICO JUNIOR COLLEGE

SPECIFICATIONS

1. **SERVICES** – New Mexico Junior College is soliciting Requests for Proposals (RFPs) to select an Independent Public Accountant (IPA) to conduct the financial audit of the College for fiscal year 2004-2005. The financial audit shall comprise the entire operations of New Mexico Junior College, including but not limited to: 2004 990T exempt organization business income tax return, a federal single audit, and consultation services for the implementation of GASB 39 and SAS 99. The College may opt to renew the contract on a year-by-year basis for up to two additional years. Such renewal, if granted, shall be contingent upon the mutual consent of both parties and sufficient appropriations and authorizations being made by the Legislature of New Mexico for the performance of this contract.
2. **PROFESSIONAL REQUIREMENT** – In order to submit a proposal, IPAs must be currently licensed and in good standing with the New Mexico State Board of Public Accountancy and appear on the New Mexico State Auditor's approved listing of IPAs for performing public audits.
3. **SCOPE** – The proposing IPA is independently responsible for determining the nature, scope, and depth of the audit services to be performed before submitting a proposal. IPAs may request to physically inspect sample documents maintained by the NMJC Business Office in this assessment.
4. **AUDIT CONTRACT** – The successful IPA shall be required to execute the official State of New Mexico Audit contract issued through the State Auditor's Office (sample copy attached), the terms of which shall become an integral part of the requirements of this proposal.
5. **AUTHORITIES** – The audit shall be conducted by the IPA as per all the requirements of Audit Rule 2.2.2 NMAC dated March 30, 2004 titled "Requirements for Contracting and Conducting Audits of Agencies" (copy included) and all other authorities relative to higher education and New Mexico local public bodies.
6. **AUDIT REPORT DEADLINE** – The final deadline for submitting the audit report to the State Auditor's Office is November 15, 2004.
7. **PROPOSAL EVALUATION CRITERIA** – The IPA shall be evaluated on the basis of the criteria set forth in 2.2.2 NMAC Audit Rule Appendix B (See pages 84 and 85). The IPA should submit sufficiently detailed information in his/her proposal to demonstrate competency or compliance as enumerated in the Audit Proposal Evaluation Criteria in Section A of this RFP #84.
8. **AUDIT REPORT** – The IPA shall submit twenty (20) original audit reports to NMJC on or before the audit report due date. The IPA is responsible for typing, reproduction and assembly of the reports.
9. **COST** – The cost of services shall be evaluated according to the weighing method outlined in Part Two of the Evaluation Form only for the top three candidates from Part One. IPAs should complete the Bid Price Form, breaking down the cost by category and estimated hours of completion. Gross receipt tax should be excluded.

10. MATERIALS TO BE SUBMITTED – There are materials that shall be submitted by the IPAs as part of the RFP process. They are as follows:

- ❖ **NMJC Bid Price Form (copy attached in Section A).**
- ❖ **B. Firm Profile that addresses in detail all the evaluation points as described in the State Auditor's Instructions for Completing Agency Audit Contract Proposal Evaluation Form (Instructions attached in Section A).**
- ❖ **Firm's most recent peer review.**

NEW MEXICO JUNIOR COLLEGE
AUDIT PROPOSAL EVALUATION CRITERIA

SECTION A

The following instructions have been issued by the State Auditor's Office to agencies for the purposes of evaluating the IPA's Proposal.

Please submit sufficiently detailed information with your proposal that addresses each of the points listed in order for your proposal to be properly evaluated.

Firms are required to provide a complete copy of their most recent peer review.

NEW MEXICO JUNIOR COLLEGE

Instructions for Completing Agency Audit Contract Proposal Evaluation Form

Part One

The Agency evaluation team is to complete this form for each Audit Firm proposal. If you are evaluating the second or third year of a multi-year proposal, complete only Part Two of the Evaluation Form.

1. Complete top portion of this form by entering:

- 1) The name of your agency;
- 2) The name and phone number of the contact person in your Agency;
- 3) The name of the Audit Firm ("Firm") you are evaluating; and
- 4) The date you are completing this form.

Section 1 Capability of Firm

A. Firm resources to perform the type and size of audit required.

- 1) Enter the number of staff the Firm proposed to work on your Agency audit.
- 2) Enter the total number of hours the Firm proposed to work on your Agency audit.
- 3) Enter the total number of hours the Firm proposed to work on your Agency audit
- 4) Enter points for sufficiency and reasonableness of proposed Firm staffing and hours.

B. The Firm meets independence standards to perform your audit

1) Enter points for the Firm's personal or organizational independence. The Agency should ask the Firm to stipulate work performed for the Agency during the last 3 years and to mention any relationships or situations that might be viewed as a potential or actual conflict of interest. In addition, the Agency should consider how others outside the Agency might view relationships where the Firm provides both audit and management services.

C. Quality Control Reviews

C.1 Peer review results

- a) Obtain a copy of the most recent peer review (must have been performed within the most recent three years).
- b) Enter the type of opinion received.
- c) Enter points for the opinion received and review results.

C.2) State Auditor review results – To be provided at a later date.

C.3) Reference checks and prior experience

a) Enter points for results of reference checks or your Agency's prior experience with the Firm. Reference checks should include past engagements of similar agencies and of key audit team members. Prior experience could include reviewing the previous evaluation form and determining that the Firm met proposed goals and used proposed staff.

C.4) Timeliness – To be provided at a later date.

D. Organization and completeness of proposal or bid

a) Enter points for overall responsiveness of the proposal or bid and completeness in following specifications.

Section 1 Total – Add up and enter the total number of points awarded for Section 1.

Section II Work Requirements & Technical Approach

A) Knowledge of audit objectives, agency needs and product to be delivered

1) Enter points for indication the Firm understands the scope of work to be done, knowledge of objectives, and agency needs.

B) Sound technical plan and realistic estimate of time

1) Enter the proposed start date

2) Enter the proposed end date

3) Enter points for the Firm's development of a realistic plan and time estimates to complete major segments of the audit: planning; interim fieldwork; fieldwork; and reporting.

C) Plans for using auditee staff; including internal auditors

1) Enter points for the Firm's development of a realistic plan and time estimates for using Agency staff, including using the work internal auditors.

D) Multi-year proposals

1) Enter points for the Firm's development of a realistic approach for planning and conducting the audits of subsequent years.

Section II Total – Add up and enter the total number of points awarded for Section II.

Section III Technical Experience

A) Enter points for On-site manager's governmental audit experience

1) Enter the name of the proposed on-site manager

B) Enter points for the Team's audit experience for the following:

1) Specialization in your type of agency (e.g. state agencies, schools, hospitals, counties, cities, etc.)

2) GASB 34 and 35 Experience

3) Experience with Housing Authorities

4) Experience with Charter Schools

C) Enter points for attendance at continuing professional education seminars or meetings on auditing, accounting, and regulations directly related to state and local government audits and the agency.

Section III Total – Add up and enter the total number of points awarded for Section III.

Section IV Firm Strengths or Weaknesses

- 1) Specify any other firm strengths and weaknesses.
- 2) Enter points for any other Firm strengths, offset by points deducted for weaknesses as noted in the Firm's proposal or bid. Indicate any other factors based on experience that may be relevant to evaluation of this Firm.

Section IV Total – Add up and enter the total number of points awarded for Section IV.

Add up and enter the total number of points awarded for all sections.

Repeat all steps for all proposals or bids received.

Determine the top three proposals with the highest scores for Part One.

Evaluate cost separately for the top THREE CHOICES.

Continue with Part Two of the Evaluation Form and add parts ONE and TWO in making your FINAL recommendations.

NEW MEXICO JUNIOR COLLEGE

BID PRICE FORM

RFP#84 - AUDIT SERVICES

Name of Firm: Johnson, Miller & Company

Contact Name: David Wheat

Address: 225 E. Bender

Hobbs, NM 88240

Telephone: 505-393-2171

	2003/2004		2004/2005		2005/2006		Combined
	Hours	Cost	Hours	Cost	Hours	Cost	Cost
Financial Statement Audit	315	\$19,090	315	\$20,045	315	\$21,050	\$60,185
Federal Single Audit	80	\$4,850	80	\$5,095	80	\$5,350	\$15,295
990 Tax Return for Estacado Library Information Network	12	\$730	12	\$770	12	\$810	\$2,310
Consultation services for GASB 39	6	\$365					\$365
Consultation services for SAS 99	12	\$730	12	\$770	12	\$810	\$2,310
New Mexico Junior College Foundation*	199	\$10,865	199	\$11,410	199	\$11,980	\$34,255
Other (if applicable, describe in detail below)							
TOTAL PROPOSED FEES		\$36,630		\$38,090		\$40,000	\$114,720

*This is a component unit. It has NOT been audited and will require preliminary test work.



JOHNSON, MILLER & CO.
Certified Public Accountants
A Professional Corporation

An Independent Member Of BDO Seldman Alliance

Hobbs, New Mexico
Midland, Texas
Odessa, Texas

May 12, 2004

Mr. Frank Collins
New Mexico Junior College
Office of the Purchasing Agent
5317 Lovington Highway
Hobbs, New Mexico 88240

We appreciate this opportunity to submit our proposal to you for the audit of the financial statements for the New Mexico Junior College (the College) for the year ending June 30, 2004 and the New Mexico Junior College Foundation for the year ending June 30, 2004. All references to "the College" apply to the New Mexico Junior College Foundation as well.

As requested in your Request for Proposal (RFP # 84), enclosed is the following information:

- A. Submittal Requirements
- | | |
|--------------|--------------------------------------|
| Section I. | Capability of the firm |
| Section II. | Work Requirements and Audit Approach |
| Section III. | Technical Experience |
| Section IV. | Firm's Strengths or Weaknesses |
| Section V. | Fee Proposal |
| Section VI. | Quality Review Report |

Johnson, Miller & Co. would consider the College to be an important client deserving a service team that is enthusiastic and dedicated to providing not only audit services, but also various other services that could address possible needs and desires to strengthen internal control. We encourage our clients to look upon us as their business advisors and not just as "the auditors".

We appreciate the opportunity to present our qualifications and approach to serve your needs. Please do not hesitate to call if you have any questions.

Sincerely,

Robert R. Rivinoja, CPA

SUBMITTAL REQUIREMENTS

SECTION I - CAPABILITY OF THE FIRM

A. *The Firm has the resources to perform the type and size of audit required.*

We maintain a large library of hardcopy reference material, CD-ROM materials and internet access which will be available to us during the audit.

We have resources available from our other area offices in order to meet any scheduling or staffing needs during the audit or for other accounting concerns that may arise during the year.

We have a consulting agreement that allows us to access resources of the national accounting firm of BDO Seidman LLP which has a large nationwide governmental audit practice. BDO Seidman governmental and information system audit specialists would be available for assistance if we were to encounter any unique circumstances during the engagement or for matters that arise during the year.

Johnson, Miller & Co will provide the following individuals for the audit engagement:

Charles Carlson, CPA, Partner – Charles is an Audit Partner with our Odessa audit practice. He has over twenty-seven years experience in public accounting, including the areas of taxation, accounting services, consulting, and auditing. He has gained experience as an auditor in many diverse industries including numerous audits of governmental entities, public schools, not-for-profit entities, oil and gas, and various other organizations. He has supervised various governmental audits including several of which have significant grant activity. Charles will be available for supervision and consulting to assure that the financial statements are in conformity with applicable accounting standards. He will devote between 5 and 10% of his time to the performance of the contract.

David Wheat, CPA, Audit Manager – David is an Audit Manager with our Hobbs audit practice. He has over twenty-six years experience in public accounting, including the areas of taxation, accounting services, consulting, and auditing. He has gained experience as an auditor in many diverse industries including numerous audits of governmental entities, public schools, not-for-profit entities, construction contractors, and various other organizations. He has supervised various governmental audits including several of which have significant grant activity. David will assist the Supervisor to assure that the financial statements are in conformity with applicable accounting standards. He will also assist the Supervisor to assure that audit reports are in accordance with applicable auditing standards, and will devote between 25 and 50% of his time to the performance of the contract.

Teresa Arsiaga, CPA, Supervisor - Teresa is an Audit Supervisor with our Hobbs audit practice. She has over five years experience in public accounting, including areas of taxation, accounting services, consulting, and auditing. She has gained experience as an auditor in many diverse industries including numerous audits of governmental entities, higher education, not-for-profit entities, construction contractors, and various other organizations. Teresa has supervised various governmental audits including several of which have significant grant activity. She will be responsible for the documentation and completion of the audit in an effective and efficient manner, and will devote between 50 and 75% of her time to the performance of the contract.

Tracy Baten, In-Charge – Tracy is an in-charge accountant with our Hobbs audit practice. She has over three years experience in public accounting, including areas of taxation, accounting services, consulting, and auditing. She has gained experience as an auditor in many diverse industries including numerous audits of governmental entities, higher education, not-for-profit entities, construction contractors, and various other organizations. She will be responsible for the audit fieldwork and assisting in the completion of the audit in an effective and efficient manner, and will devote 100% of her time to the performance of the contract.

Sabrina Ferrales, Staff Accountant – Sabrina is a staff accountant with our Hobbs audit practice. She has one year experience in public accounting, including areas of taxation, accounting services, consulting, and auditing. She has gained experience as an auditor in many diverse industries

including numerous audits of governmental entities, higher education, not-for-profit entities, and various other organizations. Sabrina will assist in the audit fieldwork, and will devote between 75 and 100% of her time to the performance of the contract.

B. *The firm meets independence standards to perform your audit.*

Johnson, Miller & Co., CPA's are independent with respect to your organization. In addition, Johnson, Miller & Co. has extensive systems in place to prevent actual and perceived independence problems. Furthermore, we have no knowledge of any potential conflicts of interest that could give rise to a lack of independence in appearance or fact for the New Mexico Junior College.

C. *Quality Control Reviews*

Johnson, Miller & Co. is a member of the American Institute of Certified Public Accountants' (AICPA) Securities and Exchange Commission (SEC) Practice Sector. Members of this organization are required to undergo, at least every three years, an on-site quality review conducted in conformity with the standards established by the AICPA. The Firm received its most recent quality control review in 2001. The opinion dated October 18, 2001, was unqualified and a Letter of Comments was issued. (Copies are attached).

Johnson, Miller & Co. also has implemented a Firm inter-office quality review program. The Firm's inter-office program is spearheaded by a Director and is comprised of an audit manager or supervisor from each office. Each office's completed audits and CAAT systems are subject to review by the inter-office team, exclusive of the team member who is employed at the respective office.

In looking at the timeliness of prior year audits, Johnson, Miller & Co. has completed all governmental entity audit contracts by the required due dates. Johnson, Miller & Co. strives to meet or exceed client-imposed deadlines for their annual audit engagements.

Johnson, Miller & Co. are proud to have served many New Mexico government clients. Please feel free to contact any of the individual references listed on page 7.

The following are names, phone numbers, and contact persons for three governmental audits Johnson Miller & Co. performed an audit for last fiscal year:

Roger Hines
Finance Director
City of Hobbs
Hobbs, NM 88240
(505) 397-9235

Steve Massey
County Manager
Eddy County
Carlsbad, NM 88220
(505) 887-9511

Jane Hahn
Director of Finance
Hobbs Municipal Schools
Hobbs, NM 88240
(505) 433-0100

SECTION II - WORK REQUIREMENTS AND AUDIT APPROACH

A. *Knowledge of audit objectives, agency needs, and product to be delivered.*

Our audit techniques are state-of-the-art: innovative, creative, efficient, and continually scrutinized for time and cost savings opportunities without sacrificing "coverage". Our audit approach focuses on "critical" areas, those where the greatest risk of material error exists. We do not pursue insignificant items or areas where errors are unlikely to occur or be significant.

Each member of the audit engagement team will be equipped with notebook computers to implement Computer Assisted Auditing Techniques (CAAT) which will provide the most efficient test sample selecting audit plan and procedures. The CAAT will include computerized trial balances, analytical procedures, worksheets, and audit program generation for all audit areas. Other CAAT include programs and worksheets for evaluating and testing internal controls and information systems, as well as financial statement footnotes, schedules and tables.

We will conduct the audit in accordance with generally accepted government auditing standards, the provisions of OMB Circular A-128 and federal, state and county laws, rules and regulations. Accordingly, our audit will include such tests of the accounting records and such other auditing procedures as we consider necessary in the circumstances to express an opinion on the financial statements of the College as of and for the year ended June 30, 2004. Our examination will also be conducted, as necessary, in accordance with the following:

- Government Auditing Standards issued by the U.S. General Accounting Office (GAO), revised June, 2003. Commonly referred to as the "Yellow Book", the guide defines generally accepted government auditing standards (GAGAS). GAGAS differs in many respects with generally accepted auditing standards (GAAS) as issued by the AICPA. GAAS are applicable to and generally accepted for audits conducted to express opinions on the fairness with which an organization's financial statements present the financial position, results of operations, and cash flows, i.e., nongovernmental entities. Generally, GAGAS includes many of the standards required under GAAS, however also makes various distinctions and requires supplemental standards for audits of government organizations.
- Audits of Federal Financial Assistance to State and Local Government Units issued by the GAO.
- The AICPA industry audit guide, Audits of State and Local Government Units.
- Audits for State and Local Governments, Office of Management and Budget's Circular A-133 and the Compliance Supplement for Single Audits of State and Local Governments.
- The AICPA industry audit guide, Audits of Not-for-Profit Organizations.
- 2.2.2 NMAC, "Requirements for Contracting and Conducting Audits of Agencies".
- Uniform Administrative Requirements for Grant-in-Aid to State and Local Governments.

We believe that the single audit concept provides the broadest audit coverage designed by the Federal Government in audits conducted in accordance with the Single Audit Act of 1984. We anticipate the issuance of the accountants' report for the organization to be as follows:

- Accountants' report on the fair presentation of the financial statements in accordance with generally accepted accounting principles to be included in the financial statements of the College.
- Accountants' report on internal accounting control that conforms to the guidelines set forth in the American Institute of Certified Public Accountants (AICPA) Statement on Auditing Standards No. 20 "Required Communication of Material Weaknesses in Internal Accounting Control" as well as the Federal Government guidelines set forth in the Single Audit Act of 1997 and OMB Circular A-133.
- Accountants' report on compliance with the material terms and conditions of the applicable grant agreements, regulations and laws containing an expression of positive assurance with respect to items tested and negative assurance for untested items.

B. *Proposal or bid contains a sound technical plan and realistic estimate of time to complete major segments of the audit: planning, interim fieldwork, fieldwork, and reporting.*

Johnson, Miller & Co. will utilize specific audit practice aids published by the American Institute of Certified Public Accountants and other nationally recognized practice aids to ensure all Generally Accepted Governmental Accounting Principles and Generally Accepted Auditing Standards are complied with.

We would begin our planning of the 2004 audit immediately upon notification of being awarded the contract. Below is a projected schedule of fieldwork:

July	Planning and Preliminary Fieldwork
August	Complete Audit Fieldwork
September	Complete Audit Fieldwork
October	Complete Audit Fieldwork
November	Complete Report

This time schedule, however, is flexible based on the timing of your needs and work schedule.

C. Plans for using the College's Staff, including internal auditors

Johnson, Miller & Co. will utilize the College's staff to obtain copies of computer files of all fund trial balances to import into our trial balance audit software. We will also utilize the Department of Finance's staff to obtain access to records and schedules or explain revisions to certain processing procedures, exceptions, or departures. Johnson, Miller & Co. takes pride in keeping interruptions to a minimum, avoiding disruptions to your normal operations. A comprehensive list of items needed will be supplied to the College upon acceptance of the contract.

D. If the proposal or bid is for a multi-year contract, approach for planning and conducting the work efforts in subsequent years

Johnson, Miller & Co. will utilize an audit approach that maximizes resources available and minimizes duplication of effort. All pertinent information and schedules will be carried forward to keep subsequent year requests of the organization's personnel to a minimum.

SECTION III - TECHNICAL EXPERIENCE

A. Government audit experience of on-site manager.

As mentioned previously, our unique audit approach will utilize two on-site managers with the following experience:

Name	Position	Years of Governmental Experience
David Wheat, CPA	Engagement Manager	26
Teresa Arsiaga, CPA	Supervisor	5
Tracy Baten	In-Charge	3

B. Team audit experience

- Specialization in your type of agency (e.g. not-for-profit agencies, state agencies, schools, hospitals, counties, cities, etc.).*

Johnson, Miller & Co.'s audit experience of the many governmental, not-for-profit agencies and hospitals we have served are more fully described on page 8.

- GASB 34 and 35 Experience*

GASB 34 and 35 will have a tremendous effect on the audit process, and our firm has obtained many hours of training on this topic, as well as implementing GASB 34 and 35 in the prior year for various clients.

We will assist your staff with the listing, classifying, and data input of capitalizable assets and the related calculations of book value and accumulated depreciation, including the allocation of depreciation expense to functions.

We will prepare journal entries to record capitalizable assets and depreciation expense for the year ended June 30, 2004.

Johnson, Miller & Co. has been on the forefront of this important issue for our governmental clients. We have offered training to our clients through seminars featuring nationally recognized speakers since 1996. Our staff has received in-house training and attended seminars and courses offered by the State Auditor and others throughout the process of introduction and passage of GASB 34 and 35.

Our firm has implemented GASB 34 and 35 in the prior year and is currently in the process of consulting with other governmental clients on the effects and process of implementing these far reaching pronouncements.

C. Attendance at continuing professional education seminars or meetings on auditing, accounting and regulations directly related to state and local government audits and the agency.

Johnson, Miller & Co continually meet and exceed annual continuing professional education requirements set forth by the American Institute of Certified Public Accountants and standards established by the State of New Mexico Office of the State Auditor. In addition, our firm annually attends and conducts in-house training in accounting and auditing directly related to not-for-profit and governmental agencies including the Single Audit Act Amendments of 1996 and ongoing revisions to OMB A-133.

Johnson, Miller & Co sponsors governmental accounting and auditing courses each year which are taught by accredited instructors and qualify for continuing education credit in New Mexico. The Firm requires a minimum of 24 continuing professional education hours every two years in subjects directly relating to the governmental environment or to government auditing for the individuals responsible for planning, direction, conducting substantial portions of fieldwork, or reporting on the governmental audit. These hours are obtained through a combination of Firm sponsored and other professionally sponsored seminars.

SECTION IV - FIRM STRENGTHS

Background of Firm

ORGANIZATION

Johnson, Miller & Co. is incorporated as a professional corporation under the laws of New Mexico and is authorized to operate in Texas. We are licensed to practice as certified public accountants by both the Texas and New Mexico (registration #8058) State Boards of Public Accountancy. We are in good standing with both Boards and not under any public or private reprimand. A firm profile has been submitted to and accepted by the New Mexico State Auditor for 2003.

Johnson, Miller & Co. has offices in Hobbs, New Mexico, Midland and Odessa, Texas and collectively employs approximately eighty professionals and staff.

The following summarizes, by office, the number and type of Firm personnel:

	<u>Hobbs</u>	<u>Midland</u>	<u>Odessa</u>
Partners (Directors)	3	4	3
Managers	2	2	2
Supervisors	2	3	3
Seniors	6	5	4
Other accountants	8	8	8
Other personnel	4	4	5
	<u>26</u>	<u>26</u>	<u>25</u>

Although Johnson, Miller & Co. is a local firm, we are also nationally recognized. In the April 5, 1998 issue of Accounting Today, the firm is recognized as one of the top 34 CPA companies in the country that are "fast, nimble, smart and show a propensity for growth". The publication cites Johnson, Miller & Co as an up-and-

coming, "firm to watch". We are also noted as a technical leader in the accounting profession in the Southwestern United States. The Firm is listed as the 12th highest ranked firm in "The Southwest's Top 16 Firms" by the Practical Accountant in the April, 2002 issue. In addition, Johnson, Miller & Co.'s Hobbs office is recognized annually as one of the "Leading Accounting Firms in New Mexico" by the New Mexico Business Weekly.

Government Clients Served

Johnson, Miller & Co. has experience on governmental audits including:

AGENCY AUDITED

Ector County Independent School District
Hobbs Municipal Schools
Midland Independent School District
Ysleta Independent School District
Midland College
College of the Southwest
Odessa College
Eastern New Mexico University
New Mexico Institute of Mining & Technology
City of Hobbs
City of Albuquerque
City of Denver College
City of Kermit
Housing Authority of the City of Odessa
Crane County
Midland County
Lea County
Crane Memorial Hospital
Jal Hospital District
Midland County Housing Authority
Eddy County
New Mexico Junior College
Roswell Independent School District
City of Eunice

Additional Services

We will perform the following additional services as a part of this contract that are above and beyond RFP requirements.

1. Johnson, Miller & Co. sponsors governmental accounting and auditing courses each year which are taught by accredited instructors and qualify for continuing education credit in New Mexico. Your accounting staff will be invited to attend these courses at no charge to you.
2. In our Hobbs office we maintain a large library of hardcopy reference material, CD-ROM materials and internet access which will be available to us during the audit and to you on an ongoing basis.
3. We have resources available from our other area offices in order to meet any scheduling or staffing needs during the audit or for other accounting concerns you may have during the year.
4. We have a consulting agreement that allows us to access resources of the national accounting firm of BDO Seidman LLP which has a large nationwide governmental audit practice. BDO Seidman governmental and information system audit specialists would be available for assistance if we were to encounter any unique circumstances during the engagement or for matters that arise during the year.

3. We have resources available from our other area offices in order to meet any scheduling or staffing needs during the audit or for other accounting concerns you may have during the year.
4. We have a consulting agreement that allows us to access resources of the national accounting firm of BDO Seidman LLP which has a large nationwide governmental audit practice. BDO Seidman governmental and information system audit specialists would be available for assistance if we were to encounter any unique circumstances during the engagement or for matters that arise during the year.
5. We will be available to you throughout the year for consulting and to answer any questions you may have.

AGREEMENT AND SUBMISSION OF PROPOSAL

We agree to perform the annual fiscal audit for the New Mexico Junior College, New Mexico for the period of July 1, 2003 through June 30, 2004 and the New Mexico Junior College Foundation for the period of July 1, 2003 through June 30, 2004. The undersigned certifies that there has been no collusion in the preparation of this proposal. The undersigned certifies that he/she read and understands the request for proposal and all pertinent documents, and that the Firm and/or person represented accepts these conditions and submits the proposal in full compliance therewith.

COMPANY JOHNSON, MILLER & CO.

SIGNATURE

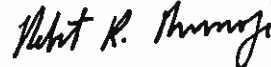

ADDRESS P.O. DRAWER 220
HOBBS, NM 88241

NAME (PRINT) ROBERT R. RIVINOJA
TITLE PARTNER

TELEPHONE 393-2171

DATE May 12, 2004

NEW MEXICO RESIDENT BIDDER CERTIFICATE # F-08058

QUALITY REVIEW REPORT



CONDLEY AND COMPANY, L.L.P.
CERTIFIED PUBLIC ACCOUNTANTS AND CONSULTANTS

993 North Third Street • P. O. Box 2993 • Abilene, Texas 79604-2993 • 915-677-6251 • FAX 915-677-0006 • E-Mail: condley@condley.com

October 18 2001

To the Stockholders
Johnson, Miller & Company, P.C.
And the SEC Practice Section Peer Review Committee
2626 John Ben Shepperd Parkway
#A-200
Odessa, Texas 79761-1951

We have reviewed the system of quality control for the accounting and auditing practice of Johnson, Miller and Company, P.C. (the firm) in effect for the year ended June 30, 2001. A system of quality control encompasses the firm's organizational structure and the policies adopted and procedures established to provide it with reasonable assurance of complying with professional standards. The elements of quality control are described in the Statements on Quality Control Standards issued by the American Institute of Certified Public Accountants (the "AICPA"). The design of the system, and compliance with it, are the responsibilities of the firm. In addition, the firm has agreed to comply with the membership requirements of the SEC Practice Section of the AICPA Division for CPA Firms (the Section). Our responsibility is to express an opinion on the design of the system, and the firm's compliance with that system and the Section's membership requirements based on our review.

Our review was conducted in accordance with standards established by the Peer Review Committee of the Section and included procedures to plan and perform the review that are summarized in the attached description of the peer review process. Our review would not necessarily disclose all weaknesses in the system of quality control or all instances of lack of compliance with it or with the membership requirements of the Section since it was based on selective tests. Because there are inherent limitations in the effectiveness of any system of quality control, departures from the system may occur and not be detected. Also, projection of any evaluation of a system of quality control to future periods is subject to the risk that the system of quality control may become inadequate because of changes in conditions, or that the degree of compliance with the policies or procedures may deteriorate.

In our opinion, the system of quality control for the accounting and auditing practice of Johnson, Miller and Company, P.C. in effect for the year ended June 30, 2001, has been designed to meet the requirements of the quality control standards for an accounting and auditing practice established by the AICPA, and was complied with during the year then ended to provide the firm

with reasonable assurance of complying with professional standards. Also, in our opinion, the firm has complied with the membership requirements of the Section in all material respects.

As is customary in a peer review, we have issued a letter under this date that sets forth comments relating to certain policies and procedures or compliance with them. The matters described in the letter were not considered to be of sufficient significance to affect the opinion expressed in this report.

Condley and Company, L.L.P.

Condley and Company, L.L.P.



CONDLEY AND COMPANY, L.L.P.
CERTIFIED PUBLIC ACCOUNTANTS AND CONSULTANTS

993 North Third Street • P. O. Box 2993 • Abilene, Texas 79604-2993 • 915-677-6251 • FAX 915-677-0006 • E-Mail: condley@condley.com

October 18 2001

To the Stockholders
Johnson, Miller & Company, P.C.
and the SEC Practice Section Peer Review Committee
2626 John Ben Shepperd Parkway
#A-200
Odessa, Texas 79761-1951

We have reviewed the system of quality control for the accounting and auditing practice of Johnson, Miller & Company, P.C. (the firm) in effect for the year ended June 30, 2001, and have issued our report thereon dated October 18, 2001. The matters described below were not considered to be of sufficient significance to affect the opinion expressed in that report, which should be read in conjunction with this letter.

Engagement Performance

Comment - Generally accepted auditing standards require that management representation letters be obtained on all financial statement and periods covered by the auditors' report. On several engagements we reviewed, the management letter did not cover the prior year when comparative financial statements were being reported on.

Recommendation - We recommend that all engagement stockholders be advised to include consideration of this requirement in their final review before releasing the auditors' report.

Condley and Company, L.L.P.
Condley and Company, L.L.P.

Invitation to Bid # 949RB

Purchase of A Road Grader

BOARD DOCUMENTS

**Date: April 20, 2004
Prepared by: Frank D. Collins
Coordinator of Purchasing**

NEW MEXICO JUNIOR COLLEGE

BOARD DOCUMENTS

General Information

1. On April 6, 2004, legal notices were sent out to three newspapers requesting sealed bids for the purchase of a road grader:
2. Hobbs Daily News Sun
Albuquerque Journal
Las Cruces News Sun
3. Bid packets were sent to five potential bidders.
4. One bidder submitted a bid within the time frame specified by the bid package.
No bidders were present at the opening.
5. The Business Office and Maintenance Department have evaluated the bid received. Their recommendation is shown on Page 3.

NEW MEXICO JUNIOR COLLEGE

BOARD DOCUMENTS

Evaluation and Recommendations

The bidder responding to Invitation to Bid #949RB was James Cecil Auctioneers of Hobbs NM.

The Administration recommends acceptance of the bid for a road grader from James Cecil Auctioneers for \$16,500.00. The specifications and bid price form may be found on Pages 4 and 5.

Source of Funding: - Maintenance – Major Equipment Account
Account #: 1-2741-15-810
Amount: \$12,500.00

Rodeo Team – Athletic Supplies Account
Account #: 2-2347-82-605
Amount: \$ 4,000.00

Total: \$16,500.00

NEW MEXICO JUNIOR COLLEGE
Invitation to Bid #949RB

Specifications & Bid Price Form

New Mexico Junior College contemplates purchasing a road grader for the maintenance department. New Mexico Junior College reserves the right to reject any and all bids on any or all item(s).

Type of road grader to be purchased:

Age: 1980 model or newer

Minimum 14 foot blade

(PLEASE SEE ATTACHED PAGE FOR FURTHER SPECIFICATIONS)

Lift blade with hydraulic controls

Enclosed cab

Diesel engine

Power steering and brakes

Bidder Name: JAMES CECIL AUCTIONEERS

Year 1980 or newer road grader:

Shipping: FOB destination to New Mexico Junior College Quantity: 1

Indicate year and model 1983 CHAMPION ART FRAME ROAD GRADER \$ 16,500.00

SN# 710A-75-19-15906 **TOTAL:** \$ 16,500.00

Have all specifications been met or exceeded?

(Circle one: YES NO)

If the answer is **NO**, attach an explanation.

CERTIFICATE OF WORKING CONDITION ATTACHED: YES NO (IF NOT, EXPLAIN):

(The certificate of working condition must be performed by an independent source; not someone from your firm or company - If the certificate of working condition is not attached as part of your response and delivered before the due date, your bid will be considered non-responsive)

DATE OF DELIVERY: IMMEDIATELY UPON YOUR REQUEST

The bidder agrees to provide NMJC the road grader as specified and at the price indicated on this form in accordance with all terms and conditions included in this invitation to bid.

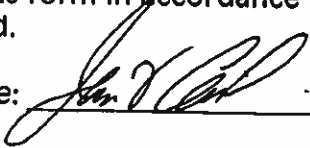
Bidder signature:  Title: OWNER

Date: 4-19-04

ROAD GRADER SPECIFICATIONS
FOR BID #947

1983 CHAMPION MODEL 710A ROAD GRADER, SN#710A-75-1915906

ENGINE: 1983 Cummins VT-378 w/throttle controls & fuel system, air cleaner and radiator installation.

TRANSMISSION: Clark 18,000 Power Shift transmission w/clutch and control valve, Clark 272.7 convertor, Clark 272.7 and 273.5 convertor circuit.

POWER TRAIN: Drive Shaft upper and lower, wheels and tires, Eaton final drive assembly, Eaton final drive tandem assembly.

Art Framed Motor Grader w/enclosed cab and components:

Steering System: Front axle, steering unit and column, steering cylinder and circuit, forward section, leaning wheel cylinder and circuit, articulation joint and indicator.

Circle Drawbar & 14' Moldboard - Circle and drawbar assembly, circle turn cylinder and circuit, circle turn valve and mount assembly, side shift and slide shift cylinders and circuits, power tilt moldboard and cylinder and circuit.

Blade Lift: Blade lift and controls, blade lift cylinder and circuit.

Hydraulics: Hydraulic pumps, pump driveshaft installations, manifold controls solenoid valve-articulation, manifold valve assembly-dual flow hydraulics, primary hydraulic circuit.

Brakes: Brake pedal and circuit installation-power brakes, master cylinder and booster assembly-power brakes, wheel brake and cylinder assembly, parking brake installation.

Tire Size: 17.5-25 Nylon, 50% or better.

Batteries: Four new heavy duty batteries.

Invitation to Bid # 951

Materials for the Construction of Horse Stalls

BOARD DOCUMENTS

**Date: May 14, 2004
Prepared by: Frank D. Collins
Coordinator of Purchasing**

NEW MEXICO JUNIOR COLLEGE

BOARD DOCUMENTS

General Information

1. On May 3, 2004, legal notices were sent out to three newspapers requesting sealed bids for the purchase of materials for construction of horse stalls:
2. Hobbs Daily News Sun
Portales New Tribune
Clovis Journal
3. Bid packets were sent to four potential bidders.
4. Two bidders submitted a bid within the time frame specified by the bid package. The bidders were not present at the opening.
5. The Business Office and Rodeo Athletics have evaluated the bids received. Their recommendation is shown on Page 3.

NEW MEXICO JUNIOR COLLEGE

BOARD DOCUMENTS

Evaluation and Recommendations

The bidders responding to Invitation to Bid #951 were Standard Steel Inc., Odessa TX and Steel Depot, Hobbs NM.

The Administration recommends acceptance of the bid for materials for the construction of horse stalls from Steel Depot for \$14,489.09. The bid tabulation is shown on Page 4.

Source of Funding: - Supplies and Expense – Rodeo Athletics
Account #: 2-2347-82-605
Amount: \$7,244.54

Capital Improvements – BRR –Rodeo Arena
Account #: 9-2729-02-023
Amount: \$7,244.55

TOTAL: \$14,489.09

NEW MEXICO JUNIOR COLLEGE				
Invitation to Bid #951 Specifications Bid Tabulation				
QUANTITY	DESCRIPTION	LENGTH	STEEL DEPOSIT PRICE	STANDARD STEEL PRICE
3,020 feet	8" Cee Purlin 14 gauge			
1,000 feet	4" Cee Purlin 14 gauge			
84 sheets	24'6" White R Panel	2,009 feet		
95 sheets	9' White R Panel	855 feet		
58 sheets	10' White R Panel	580 feet		
41 sheets	28' White R Panel	1,148 feet		
6,800	Self driller screws			
2,050	Lap screws 7/8			
94 rolls	Tacky tape			
	TOTAL		\$14,489.09	17,773.80

RESOLUTION

Diann A. Megert

- WHEREAS,** **Diann A. Megert** being one of the Staff Members of New Mexico Junior College, has faithfully served the College for 21 years, and
- WHEREAS,** **Diann A. Megert** has served as Professor of Data Processing/Mathematics/AVHS from 1983-1990, and
- WHEREAS,** **Diann A. Megert** has served as Professor of Computer Science/Mathematics from 1990-2004, and
- WHEREAS,** **Diann A. Megert** has served as Instructor for Continuing Education/Community Service 1995, and
- WHEREAS,** **Diann A. Megert** has served on various committees at New Mexico Junior College and in the community, and
- WHEREAS,** **Diann A. Megert** has been a devoted, enthusiastic and loyal staff member at New Mexico Junior College, and
- WHEREAS,** **Diann A. Megert** as a staff member, has always reflected a favorable image for New Mexico Junior College, and
- WHEREAS,** **Diann A. Megert** has elected to retire the 1st day of July, 2004.

NOW, THEREFORE BE IT RESOLVED that **Diann A. Megert** be declared Professor Emeritus of New Mexico Junior College with all the rights and privileges pertaining thereto;

ADOPTED THIS 20th day of May, 2004.

ATTEST:

New Mexico Junior College Board Chairman



New Mexico Junior College Board Secretary

RESOLUTION

Constance M. Robinson

- WHEREAS,** **Constance M. Robinson** being one of the Staff Members of New Mexico Junior College, has faithfully served the College for 7 years, and
- WHEREAS,** **Constance M. Robinson** has served as Coordinator of Tutoring/ Supplementary Instruction from 2000-2004, and
- WHEREAS,** **Constance M. Robinson** has served as Coordinator of Learning Assistance from 1996-2000, and
- WHEREAS,** **Constance M. Robinson** has served on various committees at New Mexico Junior College and in the community, and
- WHEREAS,** **Constance M. Robinson** has been a devoted, enthusiastic and loyal staff member at New Mexico Junior College, and
- WHEREAS,** **Constance M. Robinson** as a staff member, has always reflected a favorable image for New Mexico Junior College, and
- WHEREAS,** **Constance M. Robinson** has elected to retire the 1st day of May, 2004.

NOW, THEREFORE BE IT RESOLVED that New Mexico Junior College desires to give special recognition and appreciation to **Constance M. Robinson** for her service and dedication to New Mexico Junior College.

ADOPTED THIS 20th day of May, 2004.

ATTEST:

New Mexico Junior College Board Chairman



New Mexico Junior College Board Secretary

RESOLUTION

Steven J. Barslou

- WHEREAS,** Steven J. Barslou being one of the Staff Members of New Mexico Junior College, has faithfully served the College for 20 years, and
- WHEREAS,** Steven J. Barslou has served as Professor of Computer Science from 1984-2004, and
- WHEREAS,** Steven J. Barslou has served as Department Chairperson from 2000-2004; and
- WHEREAS,** Steven J. Barslou has served as Advisor for the Alliance for Minority Participation Mentorship 2001-2003, and
- WHEREAS,** Steven J. Barslou has served as Student Success Facilitator 1995, and
- WHEREAS,** Steven J. Barslou has served as Instructor for Continuing Education/Community Service 1995, and
- WHEREAS,** Steven J. Barslou has served on various committees at New Mexico Junior College and in the community; and
- WHEREAS,** Steven J. Barslou has been a devoted, enthusiastic and loyal staff member at New Mexico Junior College, and
- WHEREAS,** Steven J. Barslou as a staff member, has always reflected a favorable image for New Mexico Junior College, and
- WHEREAS,** Steven J. Barslou has elected to retire the 1st day of July, 2004.

NOW, THEREFORE BE IT RESOLVED that **Steven J. Barslou** be declared Professor Emeritus of New Mexico Junior College with all the rights and privileges pertaining thereto;

ADOPTED THIS 20th day of May, 2004.

ATTEST:

New Mexico Junior College Board Chairman



New Mexico Junior College Board Secretary

NEW MEXICO JUNIOR COLLEGE
Personnel Recommendation for Board Consideration



The following candidate is being recommended for employment as follows: Date April 29, 2004

Candidate's name Terry Holloman

Position title Professor of Reading and Writing in Transitional Studies

New position Existing position Classification Faculty Professional Other

Is candidate related to another NMJC employee? yes no If so, to whom

Effective date of employment August 16, 2004 Standard contract length 12 mos. 9 mos. other

Funding source institutional funds

Paid advertising beyond *standard Chronicle of Higher Education website

(* Standard: The Hobbs News-Sun, Direct Mail to approximately 51 colleges in a 5-state region, NM Dept. of Labor, NMJC Website, KLMA Radio & Lubbock TX Workforce Development Website)

Posted salary range \$31,461 to \$39,326 Recommended annual salary \$31,500 Prorated salary yes no
(Employment date through June 30)

Account number(s) with respective % allocation(s) 1-2011-13370

Recommended and approved by:

Marilyn Jackson
Supervisor

B Fleming
Vice President

Marilyn Jackson
Dean/Director

Steve McClary
President

Selection Committee Members:

Marilyn Jackson - Dean, Transitional Studies
Lynda Newman - Professor Reading/Education
Patsy Gale Lewis - Prof. Reading/Writing in TS.
GREG HAMMOND - PROFESSOR OF ENGLISH

Comments: Ms. Holloman meets and/or exceeds the minimum qualifications for this position.

ABBREVIATED RESUME

Position

Professor of Reading/Writing in Transitional Studies (Developmental)

Personal Data

Name: Terry A. Holloman

Education

B.A., Lubbock Christian University, Lubbock, TX, 1982

Professional Experience

College of the Southwest, Hobbs, NM 1998 to Present
P-T Adjunct Professor

Taylor Street Church of Christ, Hobbs, NM 1992 to Present
P-T Volunteer Director of Children's Education, Preschool

New Mexico Junior College, Hobbs, NM
P-T Transitional Studies English Instructor 8/03 to 12/03
Temp. P-T Upward Bound English Literature Teacher 6/03 to 7/03

Organizations/Awards

Graduated, Summa Cum Laude, from Lubbock Christian University, 1982
Meals on Wheels
PTA, Vice President, Mills Elementary



New Mexico Junior College

Career Opportunities

Position Announcement • February 2004

Position Title: Professor of Reading/Writing in Transitional Studies (Developmental)

Position Description: This position reports to the Dean of Transitional Studies. Duties and responsibilities include, but are not limited to, the following: (1) teach classes (day and/or evening) in Reading and/or Writing (Review of English); (2) serve on college committees as assigned; (3) work with learning communities; (4) post and maintain approved office hours per week; (5) assume other professional responsibilities associated with the position of professor; and (6) nothing contained herein shall limit the president in assigning the employee to any of the various college activities for which he/she would be qualified in order to meet the needs of New Mexico Junior College.

Qualifications: Bachelor's Degree in a related field from a regionally accredited institution is required. Master's degree preferred. Teaching experience in reading, writing, and/or language arts required. Community college teaching experience in developmental education preferred. Must be committed to excellence in instruction and willing to work with other instructors in coordinating the offerings and providing substitute instruction when needed. Computer proficiency required.

Salary/Benefits: Salary is based on the NMJC faculty salary schedule and is commensurate with education and experience for a nine month position. The successful applicant may have the option of teaching during the summer terms for income above his/her salary. Standard NMJC benefits apply. NOTE: NMJC does not participate in social security deductions.

Application Deadline: Open until filled. Interviews will be conducted by a selection committee and will commence upon receipt of completed applications by qualified candidates. Position starts 2004 Fall semester. To ensure consideration, all application materials must be received by the deadline. Please do not send any application materials via e-mail.

To Apply: Submit NMJC application form, letter of application, resume, unofficial transcripts (official transcripts required prior to employment), and three or more letters of reference to:

Lisa Brown
Director of Human Resources
New Mexico Junior College
5317 Lovington Highway
Hobbs, NM 88240

New Mexico Junior College is an Equal Opportunity, Affirmative Action Employer and does not discriminate against any applicant for employment because of race, color, national origin, sex, age, disability, or veteran status. Qualified applicants are encouraged to apply.

"Equal Opportunity Education and Employment"

5317 Lovington Highway, Hobbs, NM, 88240 • Phone: (505) 392-5229 • Fax: (505) 392-3589 • Toll Free: 1-800-657-6260 • E-mail: lbrown@nmjc.edu

APPLICANT LIST

Position: Professor of Reading/Writing in Transitional Studies (Developmental)

<u>Applicant</u>	<u>Interview</u>	<u>Offer</u>	<u>Remarks</u>
Zhang, Yuanzhong	No	No	
Elliott, Susan	Yes	No	
Mills, Jeffrey	No	No	
Drennan, Alan	No	No	
Garcia, John	No	No	
Eggleton, Travis	No	No	
Davis, Nancy	No	No	
Spell, Bomani	No	No	Incomplete application materials.
Ball, Elizabeth	No	No	Incomplete application materials.
Holloman, Terry	Yes	Yes	Start date: pending Board approval.
Collins, D. Anthony	No	No	
Evans, Derelle	No	No	
Reiff, Francis	Yes	No	Cancelled interview.
Garza, Sandra	No	No	
Boroianu, Simona	No	No	
Day, Joanna	No	No	
Rainwater-Kinabrew, Teena	No	No	
DuPre, Michael	No	No	Incomplete application materials.

Position: Professor of Reading/Writing in Transitional Studies (Developmental) (continued from page 1)

<u>Applicant</u>	<u>Interview</u>	<u>Offer</u>	<u>Remarks</u>
Edwards, April	No	No	
Cherryhomes, Gilbert	No	No	
Latham, Lisa	No	No	
Dill-Lanham, Diane	No	No	Incomplete application materials.
Mason, Robert	No	No	
Napp, Anna	No	No	
Aleman, Sandra	No	No	
Watts, Robert	No	No	Incomplete application materials.
McNaney, Joanna	No	No	Incomplete application materials.
Peterson, Denise	No	No	Incomplete application materials.
Espino, Antonia	No	No	Incomplete application materials.